



Dalebrook[®]

PRODUCT
CATALOGUE
2026/7



Dalebrook[®]

Trusted Since 1945

81 Years of food display expertise. Infinite possibilities in design

For over eight decades, Dalebrook has shaped the way food is presented across retail, hospitality and catering environments worldwide. From independent delis to global supermarket groups, from hotel buffets to contract catering, every display begins with intelligent design and ends with dependable performance.

With bespoke counter design, modular display systems and one of the most comprehensive product libraries in the industry, Dalebrook supports projects from first concept through to installation.

Designed by experts, chosen by professionals

Our accreditations



Our associated partners



All food displays. One partner. Dalebrook.

Dalebrook supports every sector where food is presented, served or sold. Our collections are created to respond to the operational realities of each environment while maintaining a consistent design language.

OUR EXPERTISE COVERS:

Retail

Structured fresh food counters that maximise visibility and maintain hygiene

Buffet

Layered layouts that guide flow and increase perceived abundance

Tableware

Contemporary collections that elevate plated presentation

Contract Catering

Durable, reusable systems for high turnover service

Healthcare and Education

Durable, practical formats that support independence and safety

No matter the counter, we deliver solutions that work beautifully in practice and in presentation.



STANDARDISED FOOTPRINTS THAT BUILD SMARTER DISPLAYS

Dalebrook works within recognised professional sizing systems to ensure flexibility and compatibility across service environments.

Gastronorm

Gastronorm, commonly known as GN, is the global sizing standard used across professional kitchens and catering. Using GN-compatible products allows counters to remain adaptable, scalable and efficient.

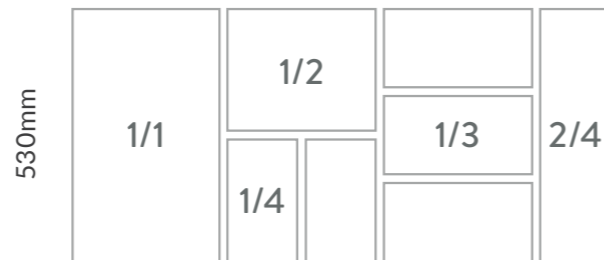

1/1 GN	530 X 325mm	1/4 GN	265 X 162mm
1/2 GN	325 X 265mm	1/6 GN	176 X 162mm
1/3 GN	325 X 176mm	2/4 GN	530 X 162mm

840 system

Developed to fit within a standard 840mm deep counter, this footprint allows flexible configuration across retail and fresh food environments. Products can be positioned horizontally or vertically to create multiple structured layouts without wasted space.

LARGE	280 X 420mm
SQUARE	280 X 280mm
MEDIUM	280 X 210mm
SMALL	280 X 140mm
X SMALL	140 X 210mm



6

Contents

Display	Rectangular Buffet Stands	Risers	HPL Risers	Crate Risers	Circular Buffet Stand	Manhattan	Inter Stands	Cake Display	Loom Pedestal	Talon Loom Pedestal	Talon Tea Stand	Tea Stand	Bon Bon	Wood Bark	Nimble	Poly Wicker				
	Page	15	16 - 21	23	27	27	30 - 33	35	37	39	41	43	47	49	63	119	137			
Trays	Slabs	Slate-Effect	Frame	Wood Bark	Rustic Wood Effect	Tura Serving Tray	Aalto	Mehndi	Carrara	Wavy	Oxford	Enamelware	Deluxe Gastro & Thin Rim	Classico & Dover	Nordic	Ore	Glazz Trays			
	Page	53	55	61	63	65	69	75	77	83	85	89	91	93 - 95	103 - 105	121	141	165		
Dishes	Trafalgar	Frame	Tura Dish	Aalto	Marl	Enamelware	Deluxe Gastro	Thin Rim Gastro	Classico	Dover	Mineral	Mino	Fleur	Chunky	Kata	Nordic	Pigment	Ore		
	Page	56	61	71 - 73	75	78 - 81	91	93	95	99	101	105	109	111	113	117	121	129	141	
Bowls	Talon	Mehndi	Marl	Crescent	Casablanca	Pigment	Urban	Ripple	Mezze	Barrel	Glazz	Mineral								
	Page	45	77	81	97	125 - 127	129	131	133	133	134 - 135	153	175							
Hot Counter	Ore	Ore Round	Stainless Steel	Silicone Utensils																
	Page	141	141	143	145															
Catering	Pots	Glazz Miniatures	Glazz Bowls	Glazz Trays	Glazz Plates	Slate-look	Eden													
	Page	149	151	153	155	157	159	189												
Food To Go	Pots	Glazz Miniatures	Glazz Plates	Hive	Hu	Kiru	Hoxton	Mayfair												
	Page	149	151	157	163	165	167	171	173											
Tableware	Aura Drinkware	Talon Tableware & Drinkware	Casablanca	Trafalgar	Marl	Enamelware	Ripple	Hoxton	Mayfair	Mineral	So.Ho.	Skillet & Orbit	Basic & Pizza	Dessert	Reef	Eden	Childrens	Omni		
	Page	11	45	125	57	81	91	133	171	173	175	177	179	183	185	187	189	190 - 193	195	
Utensils	Silicone Utensils	Dressing Pots & Ladles	Spoons	Tongs																
	Page	145	199	201	203															
Display Props	Dividers	Garnish Dividers	Garnish	Jigsaw Garnish	Double Grass Garnish	Flex	Ticket Clamps & Pins	Ticket Stands	Ticketing											
	Page	207	209	210	211	211	213	215	217	219										

www.dalebrook.com sales@dalebrook.com +44 (0) 1376 510 101

Dalebrook, Eastways Industrial Estate, Witham, Essex, England, CM8 3UA.

7

Display

Trays

Dishes

Bowls

Hot Counter

Catering

Food To Go

Tableware

Utensils

Display Props

BRAND
NEW
FOR 2026

AURA

Dalebrook[®]

tritan[™] RENEW
from Eastman

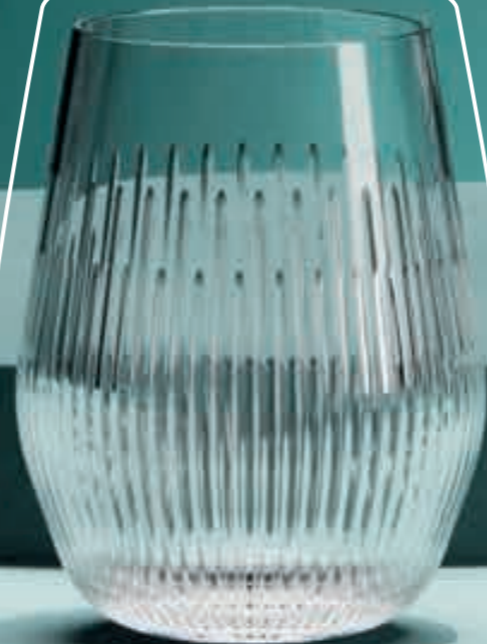



BRAND NEW
FOR 2026

Aura

Aura is glassware you can relax with. It carries the clarity of glass with the strength required for busy hospitality settings, making it ideal for poolside and high volume service. From first to last pour, Aura shapes the atmosphere and holds it.



SHATTER
RESISTANT



CRYSTAL
CLEAR



SUSTAINABLE
MATERIALS



POOLSIDE
BROCHURE



NEW

Aura Rocks Glass
Size: 88 dia. x 82mm
Capacity: 360ml / 12oz
Sold in packs of 6
■ Tritan Renew Clear TTR4451



NEW

Aura Highball Glass
Size: 67 dia. x 165mm
Capacity: 400ml / 13oz
Sold in packs of 6
■ Tritan Renew Clear TTR4452



NEW

Aura Wine Glass
Size: 90 dia. x 117mm
Capacity: 500ml / 17oz
Sold in packs of 6
■ Tritan Renew Clear TTR4454



NEW

Aura Cocktail Glass
Size: 78 dia. x 169mm
Capacity: 500ml / 17oz
Sold in packs of 6
■ Tritan Renew Clear TTR4456



Aura Rocks and Highball are designed for space-saving

WHY TRITAN™ RENEW

Tritan™ Renew from Eastman delivers the clarity and feel of glass with commercial-grade durability, making it a practical alternative where safety, volume, and sustainability are critical.

tritan™ RENEW
from Eastman

RECYCLED CONTENT

Diverting plastic waste from Landfills*

















Single use plastics are broken down and rebuilt into pristine, food-safe materials designed for repeated commercial use.

1 single-use plastic bottle is recycled to produce just one Aura glass.



Dalebrook®

Display

	15	Rectangular Buffet Stands
	16-21	Risers
	23	HPL Risers
	25	Crate Risers
	27	Circular Buffet Stand
	30-33	Manhattan
	39	Interchangeable Stands
	37	Cake Display
	39	Loom Pedestal
	41	Talon Loom Pedestal
	43	Talon Tea Stand
	47	Tea Stand
	49	Bon Bon
	63	Wood Bark
	119	Nimble
	137	Poly Wicker



GASTRONORM

Fits Gastronorm (GN) layout



1/1 GN	530 X 325mm	1/4 GN	265 X 162mm
1/2 GN	325 X 265mm	1/6 GN	176 X 162mm
1/3 GN	325 X 176mm	2/4 GN	530 X 162mm

WORKS WITH OUR GN PLATTERS (More Products Available)

	GN Urban Slab 1/2 GN TCN9212 1/3 GN TCN9213 1/4 GN TCN9214
	GN Tura Slab 1/2 GN TWD9212 1/3 GN TWD9213 1/4 GN TWD9214
	GN Carrara Slab 1/2 GN TMA9212 1/3 GN TMA9213 1/4 GN TMA9214

Rectangular Buffet Stand

Built to support 1/1, 1/2, 1/3, 1/4 and 2/4 GN platters, these stands bring structure and rhythm to the counter. Multiple height options create clear sight lines and improve product visibility without increasing footprint



1/2 GN Rectangular Buffet Stand
Size: 306 x 256 x 200mm
■ Black TB3280



1/2 GN Rectangular Buffet Stand
Size: 306 x 256 x 100mm
■ Black TB3250



1/2 GN Rectangular Buffet Stand
Size: 306 x 256 x 54mm
■ Black TB3200



1/3 GN Rectangular Buffet Stand
Size: 306 x 166 x 200mm
■ Black TB3380



1/3 GN Rectangular Buffet Stand
Size: 306 x 166 x 100mm
■ Black TB3350



1/3 GN Rectangular Buffet Stand
Size: 306 x 166 x 54mm
■ Black TB3300

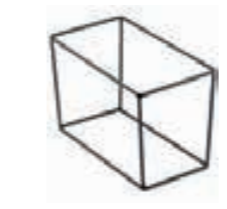

1/4 GN Rectangular Buffet Stand
Size: 245 x 152 x 200mm
■ Black TB3480



1/4 GN Rectangular Buffet Stand
Size: 245 x 152 x 100mm
■ Black TB3450



1/4 GN Rectangular Buffet Stand
Size: 245 x 152 x 54mm
■ Black TB3400





FLIP FOR MULTI FIT



ANGLE WITH NON-SLIP



TILT WITH PEAK

Risers

Height transforms a counter from flat to considered. Dalebrook's universal risers are available in a wide range of elevations, allowing operators to shape flow, guide the eye and increase perceived value. Built for food-safe environments, they add dimension without clutter.



HEIGHT OPTIONS



REVERSIBLE



STACKABLE



100mm HIGH

Embossed Pedestal Stand
Size: 170 dia 170 dia 100mmH
■ Black TB119
■ White T119



70mm HIGH

Plain Pedestal Stand
Size: 200 dia 170 dia 70mmH
■ Black TB118
■ White T118



50mm HIGH

Universal Riser
Size: 109 x 109 x 50mmH
■ Black TB117
■ White T117



150mm HIGH

Polycarbonate Twist Riser
Size: 170 dia 100 dia 150mmH
■ Black TB3615
■ Clear TC3615



100mm HIGH

Polycarbonate Twist Riser
Size: 170 dia 100 dia 100mmH
■ Black TB3610
■ Clear TC3610



50mm HIGH

Polycarbonate Twist Riser
Size: 170 dia 100 dia 50mmH
■ Black TB3605
■ Clear TC3605



ANGLE

Slanted Riser - Non Slip
Size: 90 x 90 x 30mm
■ Black TB114



MULTI

Peak Riser - Non Slip (packs of 12)
Size: 41 x 44 x 25mm
■ Black TB4125

BUFFET BROCHURE



RETAIL BROCHURE



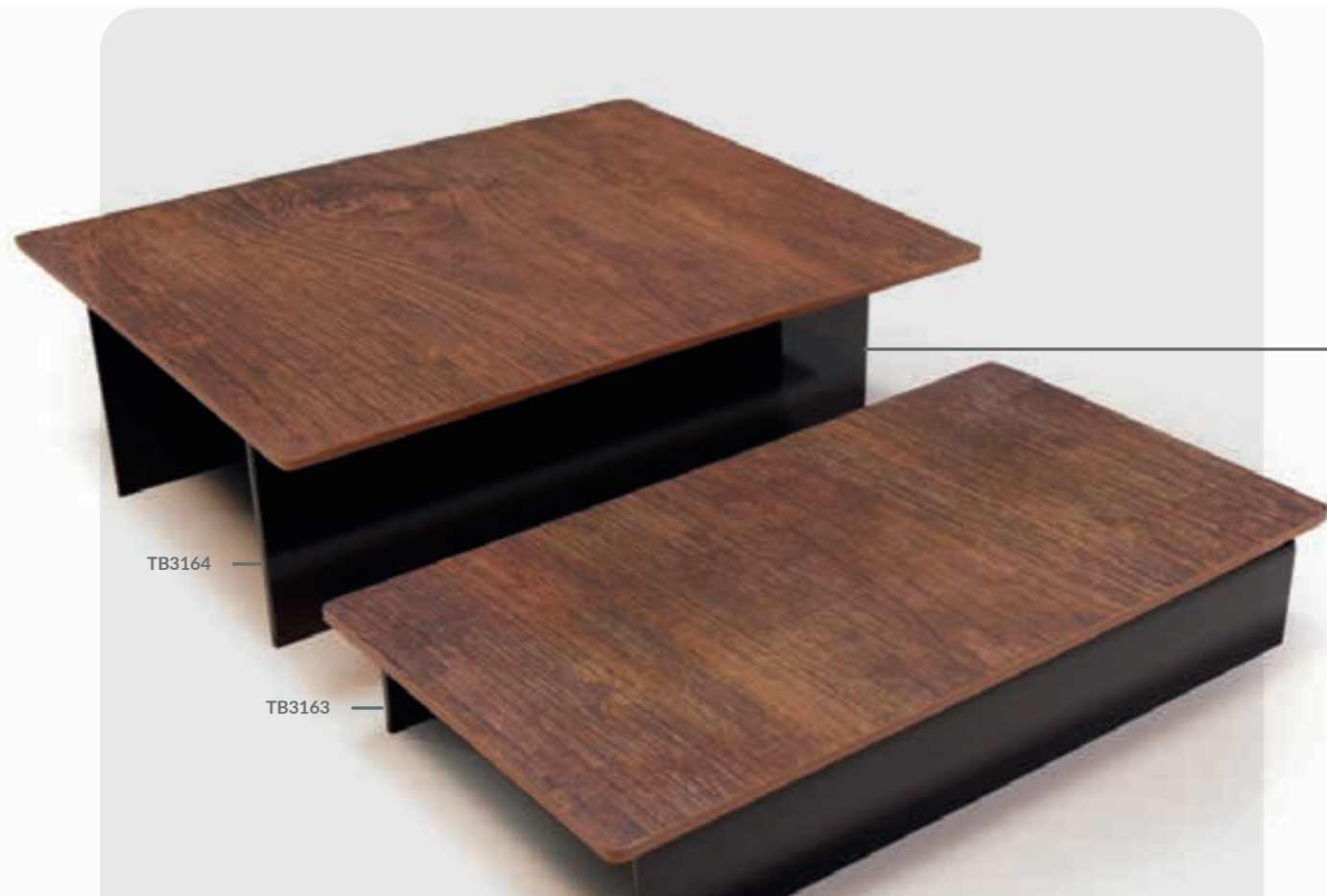

STEP RISERS

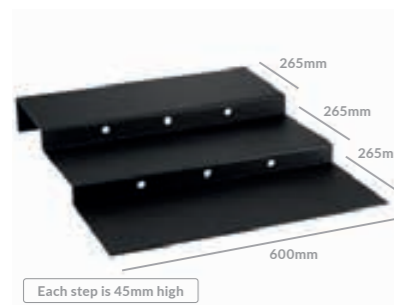

Black ABS Step Riser
Size: 795 x 600 x 90mm
■ Black TB361

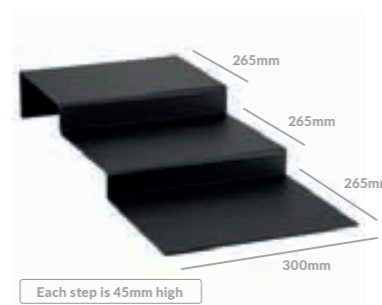

Black ABS Step Riser
Size: 795 x 300 x 90mm
■ Black TB371

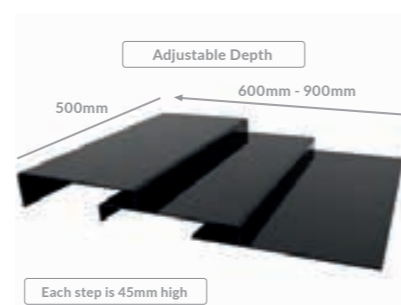

Black Acrylic Non-Slip Adjustable Step Riser
Size: 900 x 500 x 90mm
■ Black TB34

Step Risers

Introduce height while keeping focus on the food. Gloss and textured finishes offer contrast and reflect light to create a defined focal point. By tiering dishes, they improve visibility and encourage movement through the display.



STACKABLE



DURABLE



HEIGHT OPTIONS

ACRYLIC RISERS TO FIT GASTRONORM



Black Acrylic Riser
Size: 265 x 162 x 100mm
Perfect for: 1/4 Gastro
■ Black TB3164



Black Acrylic Riser
Size: 265 x 162 x 50mm
Perfect for: 1/4 Gastro
■ Black TB3163



Black Acrylic Riser
Size: 300 x 160 x 50mm
Perfect for: 1/3 Gastro
■ Black TB3161

ACRYLIC RISERS

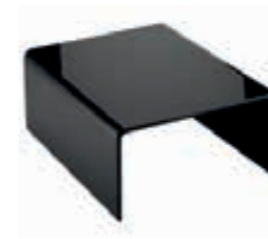

Black Acrylic Riser
Size: 300 x 250mm
■ 100mm High TB257
■ 50mm High TB256

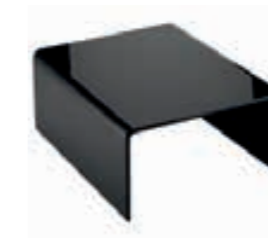

Black Acrylic Riser
Size: 305 x 250mm
■ 125mm High TB6835
■ 75mm High TB6833



Frosted Green Acrylic Riser
Size: 300 x 250mm
■ 103mm High TGC254
■ 33mm High TGC256

TEXTURED ACRYLIC RISERS



Clear Textured Acrylic Riser
Size: 305 x 250 x 125mm
Perfect for: 1/2 Gastro
■ Clear Textured TCPB6836



Clear Textured Acrylic Riser
Size: 305 x 250 x 75mm
Perfect for: 1/2 Gastro
■ Clear Textured TCPB6834



Clear Textured Acrylic Riser
Size: 305 x 250 x 40mm
Perfect for: 1/2 Gastro
■ Clear Textured TCPB6833



TBS6855

Melamine Risers

With a slate-effect finish, these risers deliver depth without the weight of real stone. Silicone feet hold them steady during busy service. They bring structure and confidence to buffet layouts.



SILICON FEET



DURABLE



HEIGHT OPTIONS

SLATE EFFECT
FITS GASTRONORME (GN) FOOTPRINT



Slate Effect Melamine Riser
Size: 325 x 265 x 100mm
Non-slip Silicone Feet

■ Black Slate Effect TBS6851



Slate Effect Melamine Riser
Size: 325 x 265 x 50mm
Non-slip Silicone Feet

■ Black Slate Effect TBS6855

TEXTURED
SLATE EFFECT



GLOSS BLACK



Melamine Riser
Size: 300 x 250 x 100mm
Non-slip Silicone Feet

■ Gloss Black TB2257



Melamine Riser
Size: 300 x 250 x 50mm
Non-slip Silicone Feet

■ Gloss Black TB2256

GLOSS
BLACK FINISH

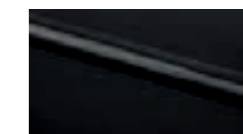

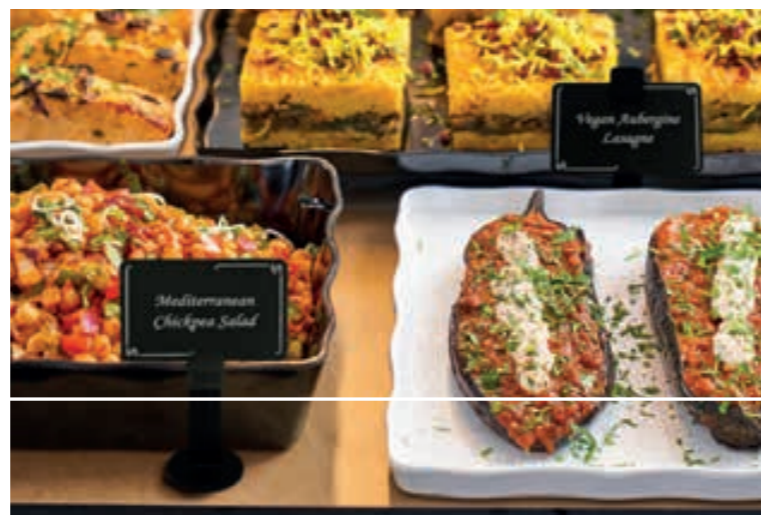

GASTRONORM (GN)



GN Three Tier Riser Set
 Total Size: 795 x 650 x 100mm
 Each Step Size: 265 x 650mm
 Step height: 15mm / 57mm / 100mm

- Carrara Marble TMA79565
- Bellato Grey TGY79565
- Kito Bronze TBZ79565
- Oak TWD79565
- Slate TBS79565

GN Three Tier Riser Set
 Total Size: 795 x 325 x 100mm
 Each Step Size: 265 x 325mm
 Step height: 15mm / 57mm / 100mm

- Carrara Marble TMA79532
- Bellato Grey TGY79532
- Kito Bronze TBZ79532
- Oak TWD79532
- Slate TBS79532

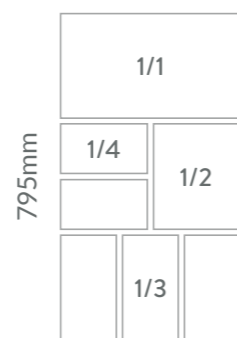

GASTRONORM (GN)

1/1 GN 530 X 325mm
 1/2 GN 325 X 265mm
 1/3 GN 325 X 176mm
 1/4 GN 265 X 162mm
 1/6 GN 176 X 162mm



CARRARA MARBLE



BELLATO GREY



KITO BRONZE



OAK



SLATE

HPL Risers

Engineered for demanding counters, HPL risers withstand moisture and heavy use. Their structure allows airflow beneath chilled units, keeping food fresh during service. Manufactured to the 840 footprint, they integrate neatly into professional layouts.



GASTRONORM & 840 SYSTEM



HEIGHT OPTIONS



DURABLE

840 SYSTEM



HPL Three Tier Riser Set
 Total Size: 840 x 630 x 100mm
 Each Step Size: 290 x 630mm
 Step height: 15mm / 57mm / 100mm

- Carrara Marble TMA84063
- Bellato Grey TGY84063
- Kito Bronze TBZ84063
- Oak TWD84063
- Slate TBS84063

HPL Three Tier Riser Set
 Total Size: 840 x 420 x 100mm
 Each Step Size: 290 x 420mm
 Step height: 15mm / 57mm / 100mm

- Carrara Marble TMA84042
- Bellato Grey TGY84042
- Kito Bronze TBZ84042
- Oak TWD84042
- Slate TBS84042

HPL Three Tier Riser Set
 Total Size: 840 x 280 x 100mm
 Each Step Size: 290 x 280mm
 Step height: 15mm / 57mm / 100mm

- Carrara Marble TMA84028
- Bellato Grey TGY84028
- Kito Bronze TBZ84028
- Oak TWD84028
- Slate TBS84028

HPL Three Tier Riser Set
 Total Size: 840 x 210 x 100mm
 Each Step Size: 290 x 210mm
 Step height: 15mm / 57mm / 100mm

- Carrara Marble TMA84021
- Bellato Grey TGY84021
- Kito Bronze TBZ84021
- Oak TWD84021
- Slate TBS84021

CORNER



HPL Corner Three Tier Riser Set
 Total Size: 840 x 840 x 100mm
 Each Step Size: 290mm
 Step height: 15mm / 57mm / 100mm

- Slate TBS84841

HPL Corner Three Tier Riser Set
 Total Size: 840 x 840 x 100mm
 Each Step Size: 290mm
 Step height: 15mm / 57mm / 100mm

- Slate TBS84842

SQUIRCL



HPL Squirrel Three Tier Riser Set
 Total Size: 840 x 420 x 100mm
 Each Step Size: 290 x 420mm
 Step height: 15mm / 57mm / 100mm

- Bellato Grey TGY42841

HPL Squirrel Three Tier Riser Set
 Total Size: 840 x 420 x 100mm
 Each Step Size: 220 x 420mm
 Step height: 15mm / 43mm / 71mm / 100mm

- Bellato Grey TGY42842

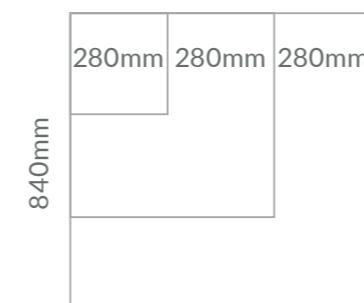

840 SYSTEM

LARGE 280 X 420mm
 SQUARE 280 X 280mm
 MEDIUM 280 X 210mm



TWD3412

TB3412

USAGE

- Buffet Display**
- Hotel
 - Restaurant
 - Caterers

- Retail Display**
- Bakers
 - Delicatessen
 - Coffee Shops

FINISHES



Tura



Slate Effect



STACK TO BUILD YOUR CRATE



STEPPED HEIGHT IN DISPLAY

Crate Riser

Stackable crate risers introduce warmth and adaptability to the counter. Layer them to build height, then top with 1/2 GN platters or dishes to vary capacity. Optional lids add practicality for prep and storage.



Tura 1/2 Size Frame Crate
 Size: 338 x 278 x 47mm
 Fits: 1/2 Gastro
 ■ Tura TWD3412



Tura 1/2 Size Frame Crate
 Size: 338 x 278 x 47mm
 Fits: 1/2 Gastro
 ■ Black TB3412



STACKABLE



TEXTURE



HEIGHT OPTIONS

WORKS WITH



Tura 1/2 Size Platter
 Size: 325 x 265 x 10mm
 ■ Black TWD9912



Black 1/2 Size Platter
 Size: 325 x 265 x 10mm
 ■ Black TB59912

WORKS WITH



Black 1/2 Size Classico Dish
 Size: 265 x 325 x 90mm
 Capacity: 4L
 ■ Black TB1292



Black 1/2 Size Classico Tray
 Size: 265 x 325 x 30mm
 Capacity: 700ml
 ■ Black TB1290



Clear Polycarbonate Raised Cover
 Size: 285 x 350 x 93mm
 ■ Clear TC9991L





- REVERSIBLE
- STACKABLE
- MULTI PURPOSE

Circular Buffet Stand

One stand, two solutions. Use upright to hold bowls and plates, or on its side to support platters and tea trays. Its tapered metal frame stacks compactly and brings a clean architectural feeling to modern service.

WORKS WITH



Metal Circular Buffet Stand
Size: 430 x 221 x 378mm
■ Black TB3600



Oxford Large Tray
Size: 530 x 195 x 17mm
■ Speckle TGT1440



Oval Wood Bark Platter
Size: 530 x 216 x 10mm
■ Wood Bark Effect TWB9653



Deep Marl Dish
Size: 385 dia. x 47mm
■ Cream TCM4605



Casablanca Dish
Size: 420 dia. x 70mm
■ Blue TBL1630

WORKS WITH



Mini Metal Circular Buffet Stand
Size: 283 x 196 x 256mm
■ Black TB3500



1/3 GN Wood Bark Effect Platter
Size: 176 x 325 x 21mm
■ Wood Bark Effect TWB9613



1/3 GN Slab Platter
Size: 325 x 176 x 20mm
■ Urban TCN9213



Pigment Bowl
Size: 338 dia. x 92mm
■ Aqua TAQ4707



Casablanca Bowl
Size: 338 x 278 x 47mm
■ Green TG1631



your
at plate

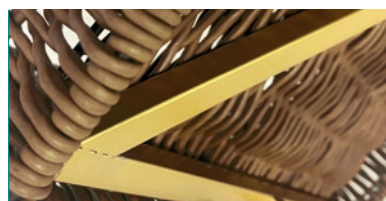

OUR BASKETS HAVE A RECESSED BASE FOR THE PERFECT FIT ON THE MANHATTAN STAND



MELAMINE SLABS FIT ONTO THE MANHATTAN STANDS, AVAILABLE IN THREE DIFFERENT FINISHES



OUR BAMBOO BOXES FIT ONTO MANHATTAN STANDS EITHER WAY UP FOR EVEN MORE VERSATILITY



REVERSIBLE MULTI HEIGHT STACKABLE

USAGE Buffet Display

- Hotel
- Restaurant
- Caterers

SIZES



Fits Gastro (GN) layout

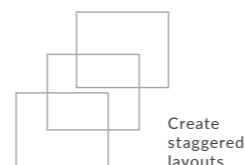

Create staggered layouts

MANHATTAN Z STAND

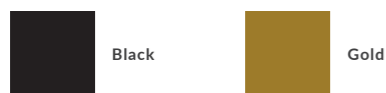

MANHATTAN H BASKET



MANHATTAN BAMBOO BOX



SLABS

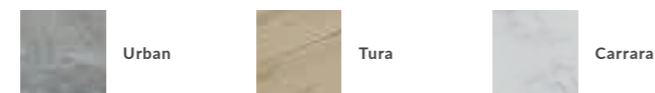

Manhattan

Sculptural Z-shaped legs nest for efficient storage while creating strong tiered displays that increase visibility. Pair with baskets, bamboo boxes or slabs in 1/1 GN and 1/2 GN sizes to balance capacity with impact.



1/1 GN Manhattan Z Stand
Size: 513 x 308 x 400mm
■ Black TSSB5503
■ Gold TGOL5503



1/1 GN Manhattan Z Stand
Size: 513 x 308 x 250mm
■ Black TSSB5502
■ Gold TGOL5502



1/1 GN Manhattan Z Stand
Size: 513 x 308 x 100mm
■ Black TSSB5501
■ Gold TGOL5501

WORKS WITH



1/1 GN Manhattan Bamboo Box
Size: 546 x 346 x 90mm
■ Black Bamboo BMO5514B
■ Natural Bamboo BMO5514



1/1 GN Black Poly-Wicker Willow H Basket
Size: 540x 345 x 100mm
■ Black TB5511
■ Willow W5511



1/1 GN Slab
Size: 530 x 325 x 20mm
■ Urban TCN9211
■ Tura TWD9211
■ Carrara TMA9211



1/2 GN Manhattan Z Stand
Size: 310 x 248 x 400mm
■ Black TSSB5506
■ Gold TGOL5506



1/2 GN Manhattan Z Stand
Size: 310 x 248 x 250mm
■ Black TSSB5505
■ Gold TGOL5505



1/2 GN Manhattan Z Stand
Size: 310 x 248 x 100mm
■ Black TSSB5504
■ Gold TGOL5504

WORKS WITH



1/2 GN Manhattan Bamboo Box
Size: 346 x 286 x 90mm
■ Black Bamboo BMO5513B
■ Natural Bamboo BMO5513



1/2 GN Black Poly-Wicker Willow H Basket
Size: 335 x 280 x 100mm
■ Black TB5512
■ Willow W5512

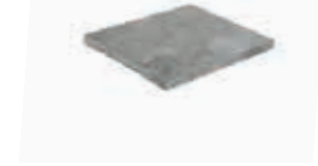

1/2 GN Slab
Size: 325 x 265 x 20mm
■ Urban TCN9212
■ Tura TWD9212
■ Carrara TMA9212



MULTIPLE COMBINATIONS



STACKING

HPL FINISHES

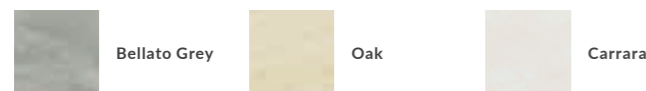

STAND FINISHES



Manhattan Round

Introducing round formats to the successful Manhattan system. Designed to support bowls and round HPL platters, they soften linear layouts and bring balance to a buffet. The sculptural frame nests efficiently for storage and adds a confident, premium presence to service. - please could you change the round text to this.

 NEW Manhattan Round Stand Size: 340 x 340 x 400mm ■ Black TSSB5509	 NEW Manhattan Round Stand Size: 340 x 340 x 250mm ■ Black TSSB5508	 NEW Manhattan Round Stand Size: 340 x 340 x 100mm ■ Black TSSB5507
 NEW Manhattan Round Stand Size: 340 x 340 x 400mm ■ Gold TGOL5509	 NEW Manhattan Round Stand Size: 340 x 340 x 250mm ■ Gold TGOL5508	 NEW Manhattan Round Stand Size: 340 x 340 x 100mm ■ Gold TGOL5507
 NEW Round Stand Size: 314 x 314 x 8mm ■ Bollato Grey TGY5510	 NEW Round Stand Size: 314 x 314 x 8mm ■ Oak TWD5510	 NEW Round Stand Size: 314 x 314 x 8mm ■ Carrara TMA5510

WORKS WITH

 Pigment Bowl Size: 338 x 338 x 92mm Capacity: 4L ■ Noir TB4707 ■ Parchment TCM4707 ■ Aqua TAQ4707 ■ Agate Grey TGY4707 ■ Himalayan TPK4707	 Marl Shallow Dish Size: 385 dia x 26mm ■ Steel Blue TBL4604 ■ Cream TCM4604 ■ Charcoal Grey TGY4604	 Casablanca Bowl Size: 350 x 350 x 70mm Capacity: 3.5L ■ Blue TBL1631 ■ Green TG1631 ■ Grey TGY1631 ■ Orange TOR1631 ■ Red TR1631 ■ White TW1631
---	---	---



Interchangeable Stands

Swap pedestals and platters to refresh layouts as menus change, creating height and visual interest in seconds. Lightweight construction makes handling simple while maintaining a refined appearance on the counter.



White Melamine Rectangular Server Top
 Size: 559 x 311 x 55mm
 Capacity: 1.5L
 ■ White M-03



White Melamine Ellipse Platter Top
 Size: 667 x 311 x 241mm
 Capacity: 3.5L
 ■ White M-04



White Melamine Round Bowl Stand Top
 Size: 406 x 406 x 279mm
 Capacity: 6L
 ■ White M-07



White Melamine Rectangular Server Top
 Size: 405 x 32mm
 ■ White M-05



White Melamine Ellipse Platter Top
 Size: 406 x 38mm
 ■ White M-06



Screw Fit Base & Top



White Melamine 200mm Pedestal Base
 Size: 203 dia. x 203mm
 ■ White M-08



White Melamine 100mm Pedestal Base
 Size: 210 dia. x 102mm
 ■ White M-09



HEIGHT OPTIONS



BUFFET



CHANGEABLE



BUFFET
BROCHURE



TC42638

TMA3028



RISERS

See Page 17 for our full selection of risers

Cake Display

Crystal-clear domes protect cakes while keeping them fully visible. Lightweight, food-safe materials support hygiene and easy handling throughout service. A simple way to maintain freshness without losing presentation impact.



White Cake Pedestal
Size: 280 dia. x 21mm
■ White M-01



Clear Acrylic Dome Cover
Size: 280 dia. x 21mm
■ Clear Acrylic TC13



Melamine Round Tray
Size: 218 dia. x 22mm
■ Black TB146
■ White T146



Slate Effect Round Platter
Size: 285 dia. x 10mm
■ Black Slate Effect TBS3285



Round Platter
Size: 285 dia. x 10mm
■ Carrara Marble TMA3028
■ Rustic Wood Effect TRW3028



Clear SAN Lid with Recessed Handle
Size: 284 dia. x 22mm
■ Clear SAN T1412



SAN Dome Lid
Size: 270 dia. x 180mm
■ Clear Handle TC42680
■ Alloy Handle TC52680



SAN Dome Lid
Size: 199 dia. x 180mm
■ Clear Handle TC42638
■ Alloy Handle TC52638



HEIGHT OPTIONS



CAKE DISPLAY



LIDS



BUFFET BROCHURE



STACKABLE



TWIST LOCK



HEIGHT OPTIONS



Taupe



Aqua



Parchment

ROUND PLATTER FINISHES

Loom Pedestal

Loom introduces a precision locking system that connects pedestal and platter securely. Available in multiple heights, it allows operators to layer displays and build vertical interest.



SAN Dome Lid
Size: 270 dia. x 180mm
■ Clear Handle TC42680
■ Alloy Handle TC52680



SAN Dome Lid
Size: 199 dia. x 180mm
■ Clear Handle TC42638
■ Alloy Handle TC52638

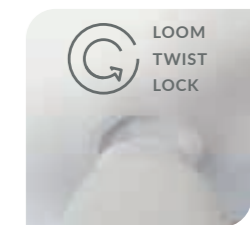

LOOM
TWIST
LOCK



Loom Cake Pedestal Flat Top
Size: 284 dia. x 22mm
with Loom Twist Lock
■ White T1412



Loom Cake Pedestal Flat Top
Size: 218 dia. x 22mm
with Loom Twist Lock
■ White T1411



Loom Cake Pedestal Wavy Top
Size: 233 dia. x 37mm
with Loom Twist Lock
■ White T1413



Round Platter
Size: 280 dia. x 21mm
with Loom Twist Lock
■ White/Taupe TW4644TP



Round Platter
Size: 280 dia. x 21mm
with Loom Twist Lock
■ Aqua TAQ4644



Round Platter
Size: 280 dia. x 21mm
with Loom Twist Lock
■ Parchment TCM4644



Loom Cake Pedestal Base
Size: 110 dia x 111mm
with Loom Twist Lock
■ White T1404



Loom Cake Pedestal Base
Size: 110 dia x 61mm
with Loom Twist Lock
■ White T1403



Loom Cake Pedestal Base
Size: 110 dia x 17mm
with Loom Twist Lock
■ White T1405





Talon Loom Pedestal

Using the Loom locking system, Talon adds colour and texture through interchangeable handles and pedestals. The textured finish brings character to counters, allowing displays to reflect seasonal themes or brand identity.

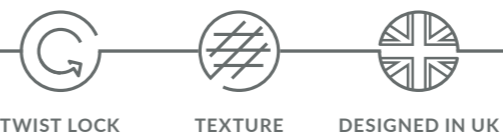

TWIST LOCK TEXTURE DESIGNED IN UK

Talon Loom Pedestal Handle
Size: 108 dia. x 114mm with Loom Twist Lock

■ Noir TB50021	■ Ash TGY50021
■ Steel TBL50021	■ Cherry TRC50021
■ Mint TMG50021	■ Oat TCM50021

■	Noir
■	Steel
■	Mint
■	Ash
■	Cherry
■	Oat

SAN Dome Lid
Size: 270 dia. x 180mm with Loom Twist Lock
■ Clear Handle TC42680

SAN Dome Lid
Size: 199 dia. x 180mm with Loom Twist Lock
■ Clear Handle TC42638

Loom Cake Pedestal Flat Top
Size: 284 dia. x 22mm with Loom Twist Lock
■ White T1412

Loom Cake Pedestal Flat Top
Size: 218 dia. x 22mm with Loom Twist Lock
■ White T1411

Talon Loom Pedestal Tall
Size: 108 dia. x 114mm with Loom Twist Lock

■ Noir TB50020	■ Ash TGY50020
■ Steel TBL50020	■ Cherry TRC50020
■ Mint TMG50020	■ Oat TCM50020

Talon Loom Pedestal Short
Size: 107 dia. x 65mm with Loom Twist Lock

■ Noir TB50019	■ Ash TGY50019
■ Steel TBL50019	■ Cherry TRC50019
■ Mint TMG50019	■ Oat TCM50019

POOLSIDE BROCHURE

TABLEWARE BROCHURE

BUFFET BROCHURE



Talon Tea Stand

Crafted in stainless steel, the Talon Tea Stand adds structure to afternoon tea service. Pair with contrasting or complementary Talon platters to control the tone of the table. A refined frame that keeps tiers balanced and secure.



LARGE RANGE



TEXTURE



DESIGNED IN UK



Stainless Steel Talon Tea Stand
Size: 330 x 177 x 28mm
■ Stainless Steel TSS50022



Noir



Ash



Steel



Cherry



Mint



Oat



Talon Platter
Size: 330 x 177 x 28mm
■ Noir TB50018



Talon Platter
Size: 330 x 177 x 28mm
■ Steel TBL50018



Talon Platter
Size: 330 x 177 x 28mm
■ Mint TMG50018



Talon Platter
Size: 330 x 177 x 28mm
■ Ash TGY50018



Talon Platter
Size: 330 x 177 x 28mm
■ Cherry TRC50018



Talon Platter
Size: 330 x 177 x 28mm
■ Oat TCM50018

POOLSIDE BROCHURE



TABLEWARE BROCHURE



BUFFET BROCHURE





Talon Bowls and Plates

Talon brings bold colour to food service without sacrificing durability. Plates can sit neatly on matching bowls to help protect food during transport and service. A confident choice for high volume hospitality that still wants personality on display.

USAGE

Buffet Display

- Hotel
- Restaurant
- Caterers

Dinning

- Restaurant
- Poolside
- Hotel



Talon Coffee Cup
Size: 87 x 76mm
Capacity: 300ml / 10oz

- Noir TB5018
- Steel TBL5018
- Mint TMG5018
- Ash TGY5018
- Cherry TRC5018
- Oat TCM5018



Talon Tea Cup
Size: 87 x 76mm
Capacity: 180ml / 6oz

- Noir TB5019
- Steel TBL5019
- Mint TMG5019
- Ash TGY5019
- Cherry TRC5019
- Oat TCM5019



Talon Espresso Cup
Size: 69 x 63mm
Capacity: 95ml / 3.2oz

- Noir TB5016
- Steel TBL5016
- Mint TMG5016
- Ash TGY5016
- Cherry TRC5016
- Oat TCM5016



Talon Espresso Saucer
Size: 109 x 18mm

- Noir TB5012
- Steel TBL5012
- Mint TMG5012
- Ash TGY5012
- Cherry TRC5012
- Oat TCM5012

Talon Tea and Coffee Saucer
Size: 148 x 18mm

- Noir TB5014
- Steel TBL5014
- Mint TMG5014
- Ash TGY5014
- Cherry TRC5014
- Oat TCM5014



Talon Large Bowl
Size: 241 x 241 x 70mm
Capacity: 1.6L

- Noir TB50015
- Steel TBL50015
- Mint TMG50015
- Ash TGY50015
- Cherry TRC50015
- Oat TCM50015



Talon Medium Bowl
Size: 193 x 193 x 70mm
Capacity: 850ml

- Noir TB50013
- Steel TBL50013
- Mint TMG50013
- Ash TGY50013
- Cherry TRC50013
- Oat TCM50013



Talon Small Bowl
Size: 140 x 140 x 70mm
Capacity: 425ml

- Noir TB50011
- Steel TBL50011
- Mint TMG50011
- Ash TGY50011
- Cherry TRC50011
- Oat TCM50011



Talon Oval Bowl
Size: 316 x 163 x 61mm
Capacity: 1.3L

- Noir TB50017
- Steel TBL50017
- Mint TMG50017
- Ash TGY50017
- Cherry TRC50017
- Oat TCM50017



Talon Large 10" Plate
Size: 251 x 251 x 25mm

- Noir TB50016
- Steel TBL50016
- Mint TMG50016
- Ash TGY50016
- Cherry TRC50016
- Oat TCM50016



Talon Medium 8" Plate
Size: 203 x 203 x 25mm

- Noir TB50014
- Steel TBL50014
- Mint TMG50014
- Ash TGY50014
- Cherry TRC50014
- Oat TCM50014



Talon Small 6" Plate
Size: 143 x 143 x 25mm

- Noir TB50012
- Steel TBL50012
- Mint TMG50012
- Ash TGY50012
- Cherry TRC50012
- Oat TCM50012



Talon Oval Platter
Size: 330 x 177 x 28mm

- Noir TB50018
- Steel TBL50018
- Mint TMG50018
- Ash TGY50018
- Cherry TRC50018
- Oat TCM50018

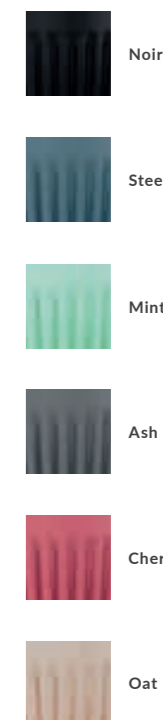

POOLSIDE BROCHURE

TABLEWARE BROCHURE

BUFFET BROCHURE



Tea Stand

A modern take on a classic ritual. Stackable construction makes storage practical while maintaining elegance during service. Built to support indulgent layered presentation without overwhelming the table.



Black Coated Tea Stand & Black Platters

- TB3000 (x1)
- TB9634 (x1)
- TB9624 (x2)



Copper Coated Tea Stand & Rustic Wood Platters

- TCOP3000 (x1)
- TRW9634 (x1)
- TRW9624 (x2)



Stainless Steel Tea Stand & Marble Platters

- TSS3000 (x1)
- TMA9634 (x1)
- TMA9624 (x2)



CAKE DISPLAY



STACKABLE



DESIGNED IN UK



Black



Rustic Wood



Carrara Marble

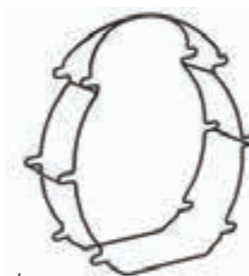

Tea Stand

Size: 362 x 135 x 385mm

- Black Coated TB3000
- Copper Coated TCOP3000
- Stainless Steel TSS000



Top/Bottom Tier Platters

Size: 246 x 140 x 8mm

- Black TB9624
- Rustic Wood Effect TRW9624
- Carrara Marble Effect TMA9624



Middle Tier Platters

Size: 346 x 140 x 8mm

- Black TB9634
- Rustic Wood Effect TRW9634
- Carrara Marble Effect TMA9634





DURABLE



LIGHTWEIGHT



LIDS

Bon Bon

Bon Bon jars deliver a crystal clear, glass-like look in strong polycarbonate. Airtight lids help keep contents fresher for longer while staying easy to handle in fast service. Available in multiple sizes to suit everything from sweets to toppings and dry goods.



Clear PC Display Container
Size: 250 dia. x 250mm
Capacity: 9.7L
■ Clear TC9119



Clear PC Display Container
Size: 250 dia. x 150mm
Capacity: 5.3L
■ Clear TC9118



Clear PC Display Container Lid
Size: 250 dia. x 87mm
■ Clear TC9250



Clear PC Display Container
Size: 200 dia. x 500mm
Capacity: 12.7L
■ Clear TC9117



Clear PC Display Container
Size: 200 dia. x 400mm
Capacity: 10L
■ Clear TC9116



Clear PC Display Container Lid
Size: 200 dia. x 87mm
■ Clear TC9200



Clear PC Display Container
Size: 175 dia. x 300mm
Capacity: 5.6L
■ Clear TC9115



Clear PC Display Container
Size: 175 dia. x 200mm
Capacity: 5.3L
■ Clear TC9114



Clear PC Display Container Lid
Size: 175 dia. x 87mm
■ Clear TC9175



Clear PC Display Container
Size: 150 dia. x 600mm
Capacity: 8.2L
■ Clear TC9113



Clear PC Display Container
Size: 150 dia. x 350mm
Capacity: 4.7L
■ Clear TC9112



Clear PC Display Container Lid
Size: 150 dia. x 80mm
■ Clear TC9150



Clear PC Display Container
Size: 100 dia. x 250mm
Capacity: 1.3L
■ Clear TC9111



Clear PC Display Container
Size: 100 dia. x 150mm
Capacity: 740ml
■ Clear TC9110



Clear PC Display Container Lid
Size: 100 dia. x 75mm
■ Clear TC9100



Trays

	53	Slabs
	55	Slate-Effect
	61	Frame
	63	Wood Bark
	65	Rustic Wood Effect
	69	Tura Serving Tray
	75	Aalto
	77	Mehndi
	83	Carrara
	85	Wavy
	89	Oxford
	91	Enamelware
	93-95	Deluxe Gastro & Thin Rim
	103-105	Classico & Dover
	121	Nordic
	141	Ore
	165	Glazz Trays



TCN9224

TB3600



Slabs

The look of marble, concrete or wood without the weight or fragility. Manufactured in GN sizes, Slabs integrate directly into professional counters while remaining lightweight and dishwasher safe.



1/1 GN Slab
Size: 530 x 325 x 20mm
■ Urban TCN9211
■ Tura TWD9211
■ Carrara TMA9211

2/4 GN Slab
Size: 530 x 162 x 20mm
■ Urban TCN9224
■ Tura TWD9224
■ Carrara TMA9224

1/2 GN Slab
Size: 325 x 265 x 20mm
■ Urban TCN9212
■ Tura TWD9212
■ Carrara TMA9212



1/3 GN Slab
Size: 325 x 176 x 20mm
■ Urban TCN9213
■ Tura TWD9213
■ Carrara TMA9213



1/4 GN Slab
Size: 265 x 162 x 20mm
■ Urban TCN9214
■ Tura TWD9214
■ Carrara TMA9214

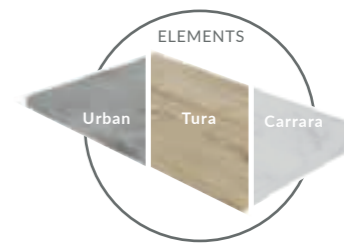
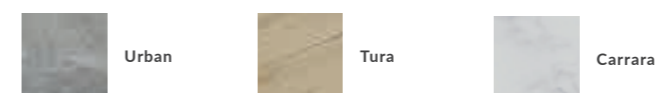

TEXTURE



GASTRONORM



LIGHTWEIGHT

SIZES

Fits Gastronorm (GN) layout



USAGE

Buffet Display

- Hotel
- Restaurant
- Caterers

Retail Display

- Butchers
- Deli
- Cheesmonger



Part of the Elements Collection



Rectangular Stands
Page 15



Manhattan Z Stands
Page 31



Circular Stand
Page 27



BUFFET BROCHURE



RETAIL BROCHURE



TBS9912

TB3250



GASTRO



TEXTURED



DESIGNED
IN UK

USAGE

Buffet Display

- Hotel
- Restaurant
- Caterers

Retail Display

- Butchers
- Deli
- Cheesmonger

ROUND



Slate-Effect Platter
Size: 285 dia. x 10mm
■ Slate Effect TBS3285



SAN Dome Lid with Alloy Handle
Size: 270 dia. x 180mm
■ Clear SAN TC52680



Slate-Effect Platter
Size: 217 dia. x 9mm
■ Slate Effect TBS3217



SAN Dome Lid with Alloy Handle
Size: 199 dia. x 180mm
■ Clear SAN TC52638

Slate-Effect

Slate character without the breakages. These lightweight platters resist chipping and include silicone feet for stability on busy counters. A darker backdrop that sharpens colour contrast and elevates simple dishes.

GASTRONORM (GN)



1/1 GN Slate-Effect Gastro Platter
Size: 530 x 325 x 10mm
■ Slate Effect TBS9911



1/2 GN Slate-Effect Gastro Platter
Size: 265 x 325 x 10mm
■ Slate Effect TBS9912



1/3 GN Slate-Effect Gastro Platter
Size: 176 x 325 x 10mm
■ Slate Effect TBS9913



1/4 GN Slate-Effect Gastro Platter
Size: 265 x 162 x 10mm
■ Slate Effect TBS9914

WORKS WITH
Fits Gastronorm (GN)



Rectangular Stands
Page 15

GASTRONORM SIZES
Fits Gastronorm (GN)



RECTANGULAR AND SQUARE



Slate-Effect Platter
Size: 285 x 600 x 10mm
■ Slate Effect TBS9986



Slate-Effect Platter
Size: 285 x 430 x 10mm
■ Slate Effect TBS9983

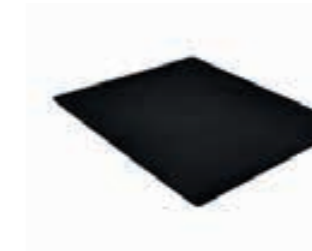

Slate-Effect Platter
Size: 285 x 285 x 10mm
■ Slate Effect TBS9981

FITS COVER



Slate-Effect Platter
Size: 285 x 350 x 10mm
■ Slate Effect TBS9982







Polycarbonate Raised Cover
Size: 285 x 350 x 93mm - Use with TBS9982
■ Clear Polycarbonate TC9991L





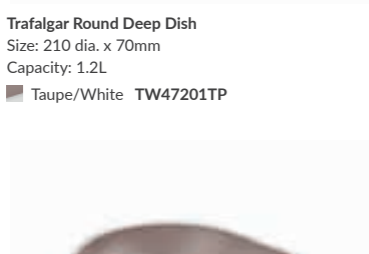





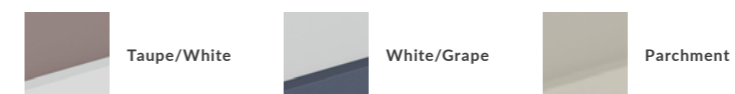

DISHES

 <p>Trafalgar Round Deep Dish Size: 210 dia. x 70mm Capacity: 1.2L ■ Taupe/White TW47201TP</p>	 <p>Trafalgar Round Deep Dish Insert Size: 110 dia. x 36mm Capacity: 700ml ■ Taupe/White TW47204TP</p>	 <p>Trafalgar Round Shallow Dish Size: 197 dia. x 38mm Capacity: 550ml ■ Taupe/White TW47202TP</p>
 <p>Trafalgar Oval Deep Dish Size: 280 x 197 x 36mm Capacity: 1.8L ■ Taupe/White TW4728TP</p>	 <p>Trafalgar Oval Deep Dish Insert Size: 280 x 197 x 36mm Capacity: 1L ■ Taupe/White TW47203TP</p>	 <p>Trafalgar Oval Square Shallow Dish Size: 267 x 197 x 38mm Capacity: 750ml ■ Taupe/White TW4729TP</p>

Trafalgar

Soft matte texture and organic form give Trafalgar a luxury feel. It acts as a calm canvas that lets ingredients lead, while premium food-grade melamine withstands constant service. Refined enough for hotel dining, robust enough for high volume environments.



 <p>Trafalgar Large Square Plate Size: 305 x 305 x 19mm ■ Taupe/White TW4723TP ■ White/Grape TW4723GRP ■ Parchment TCM4723</p>	 <p>Trafalgar Medium Square Plate Size: 254 x 254 x 17mm ■ Taupe/White TW4722TP ■ White/Grape TW4722GRP ■ Parchment TCM4722</p>	 <p>Trafalgar Small Square Plate Size: 200 x 200 x 15mm ■ Taupe/White TW4721TP ■ White/Grape TW4721GRP ■ Parchment TCM4721</p>
 <p>Trafalgar Large Bowl Size: 318 x 296 x 44mm ■ Taupe/White TW4726TP ■ White/Grape TW4726GRP ■ Parchment TCM4726</p>	 <p>Trafalgar Medium Bowl Size: 280 x 260 x 39mm ■ Taupe/White TW4725TP ■ White/Grape TW4725GRP ■ Parchment TCM4725</p>	 <p>Trafalgar Small Bowl Size: 245 x 225 x 34mm ■ Taupe/White TW4724TP ■ White/Grape TW4724GRP ■ Parchment TCM4724</p>
 <p>Trafalgar Deep Bowl Size: 191 x 191 x 78mm Capacity: 850ml ■ Taupe/White TW4727TP ■ White/Grape TW4727GRP ■ Parchment TCM4727</p>	 <p>Trafalgar Pot Size: 120 x 120 x 72mm Capacity: 325ml ■ Taupe/White TW4738TP ■ White/Grape TW4738GRP ■ Parchment TCM4738</p>	

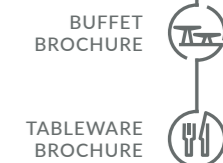

Dalebrook®





USAGE
Buffet Display

- Hotel
- Restaurant
- Caterers

Retail Display

- Butchers
- Deli
- Cheesmonger

SIZE
840 System

- Large - 420 x 280mm
- Small - 280 x 210mm

840mm	420 x 280	280 x 210
	280 x 210	

Frame

A defined border creates structure around the food, reducing the need for added garnish. Raised edges contain liquids while silicone feet keep platters secure on the counter. Built to the 840 system, Frame helps create clean, unified layouts across fresh food displays.



Black Large Frame Tray
 Size: 420 x 280 x 21mm

- Urban TCN2328B
- Tura TWD2328B
- Hay THY2328B



White Large Frame Tray
 Size: 420 x 280 x 21mm

- Urban TCN2328W



Black Large Frame Dish
 Size: 420 x 280 x 50mm

- Urban TCN2318B
- Tura TWD2318B



Black Small Frame Tray
 Size: 280 x 210 x 21mm

- Urban TCN2321B
- Tura TWD2321B
- Hay THY2321B



White Small Frame Tray
 Size: 280 x 210 x 21mm

- Urban TCN2321W
- Hay THY2321W



Black Small Frame Dish
 Size: 280 x 210 x 50mm

- Urban TCN2311B
- Tura TWD2311B
- Hay THY2311B



Black / Urban White / Urban Black / Tura White / Hay Black / Hay





DISHWASHER
SAFE



ORGANIC
SHAPES



DURABLE

Wood Bark

An organic look without the hygiene concerns natural wood. Food-safe melamine keeps these platters durable, while the round platters are compatible with Loom pedestals to introduce height.

WORKS WITH



1/3 GN Wood Bark Effect Platter
Size: 176 x 325 x 21mm
■ Wood Bark Effect TWB9613

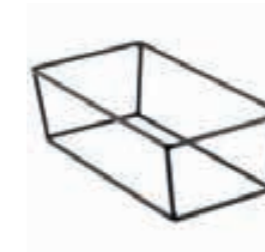

Black Rectangular Buffet Stand
Size: 306 x 166 x 100mm
■ Black TB3350



WORKS WITH



Oval Wood Bark Platter
Size: 530 x 216 x 10mm
■ Wood Bark Effect TWB9653



Black Circular Buffet Stand
Size: 430 x 221 x 378mm
■ Black TB3600



WORKS WITH



Round Wood Bark Platter
Size: 210 dia. x 14mm
■ Wood Bark Effect TWB9621



Stone Loom Cake Pedestal Base
Size: 283 x 196 x 256mm
■ Stone TST1403



LOOM
TWIST
LOCK

WORKS WITH



Round Wood Bark Platter
Size: 280 dia. x 14mm
■ Wood Bark Effect TWB9628



Stone Loom Cake Pedestal Base
Size: 110 dia. x 111mm
■ Stone TST1404





TRW9912

Rustic Wood Effect

Deeper, richer wood tones bring warmth and contrast to displays. GN sizing allows integration with rectangular stands to create layered height. A practical way to soften modern counters with natural character.

GASTRONORM (GN)



1/1 GN Rustic Wood Effect Platter
Size: 530 x 325 x 10mm
■ Rustic Wood Effect TRW9911



1/2 GN Rustic Wood Effect Platter
Size: 265 x 325 x 10mm
■ Rustic Wood Effect TRW9912



1/3 GN Rustic Wood Effect Platter
Size: 176 x 325 x 10mm
■ Rustic Wood Effect TRW9913



1/4 GN Rustic Wood Effect Platter
Size: 265 x 162 x 10mm
■ Rustic Wood Effect TRW9914

WORKS WITH

Fits Gastronorm (GN)



Rectangular Stands
Page 15

GASTRONORM SIZES

Fits Gastronorm (GN)



ROUND



Rustic Wood Effect Round Platter
Size: 285 dia. x 14mm
■ Rustic Wood Effect TRW3028

WORKS WITH



SAN Dome Lid with Alloy Handle
Size: 270 dia. x 180mm
■ Clear SAN TC52680

DESIGNED IN UK



TEXTURED



GASTRO



TURA WOOD EFFECT



RETAIL BROCHURE



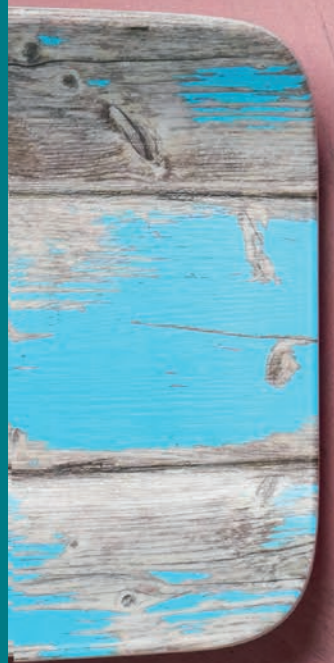
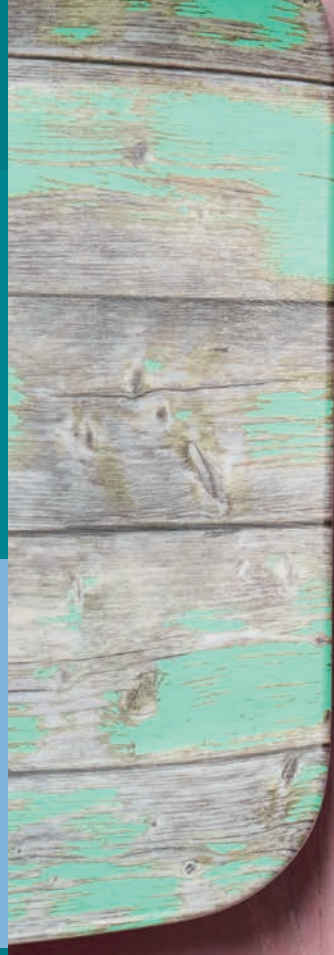

Dalebrook®



GASTRONORM SIZES

Fits Gastronorm (GN)



WOOD TEXTURE



GASTRONORM



STACKABLE

STACKABLE WITH FOOD

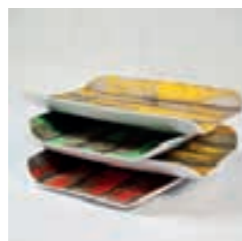

TEXTURED WOOD EFFECT



PAINTED WOOD EFFECT



WORKS WITH



TURA DISHES Page 71



TURA DISHES Page 71

Tura Serving Tray

Curved profiles bring shape without crowding the layout. Built to GN footprints these trays are available in neutral and rustic finishes to suit both contemporary and artisanal environments.

TURA



2/4 Tura Serving Tray
Size: 530 x 162 x 40mm
Tura Wood Effect TWD2460O
Gloss White T2460



1/2 Tura Serving Tray
Size: 265 x 325 x 40mm
Tura Wood Effect TWD2490O
Gloss White T2460



TURA WOOD EFFECT

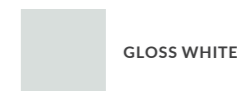

GLOSS WHITE



1/3 Tura Serving Tray
Size: 176 x 325 x 40mm
Tura Wood Effect TWD2450O



1/4 Tura Serving Tray
Size: 265 x 162 x 40mm
Tura Wood Effect TWD2480O

PAINTED WOOD EFFECT TURA



2/4 Tura Serving Tray
Size: 530 x 162 x 40mm
Teal TWD2460TL
Orange TWD2460OR
Blue TWD2460BL
Yellow TWD2460Y



1/2 Tura Serving Tray
Size: 265 x 325 x 40mm
Teal TWD2490TL
Orange TWD2490OR
Blue TWD2490BL
Yellow TWD2490Y



TEAL



ORANGE



BLUE



YELLOW



1/3 Tura Serving Tray
Size: 176 x 325 x 40mm
Teal TWD2450TL
Orange TWD2450OR
Blue TWD2450BL
Yellow TWD2450Y



1/4 Tura Serving Tray
Size: 265 x 162 x 40mm
Teal TWD2480TL
Orange TWD2480OR
Blue TWD2480BL
Yellow TWD2480Y





TWD2480OR

TWD2480OR



Tura Dish

A complete GN-compatible range built for flexibility. Inserts and lids help manage portion control and preserve freshness while keeping displays abundant. Clean lines and durable construction make Tura a dependable backbone for professional counters.

TURA WOOD EFFECT



2/4 Tura Dish
Size: 530 x 162 x 80mm
Capacity: 3.5L
■ Tura Wood Effect / White TWD7724O



1/2 Tura Dish
Size: 325 x 265 x 80mm
Capacity: 3.5L
■ Tura Wood Effect / White TWD7712O
■ Tura Wood Effect / Black TWD7712B



1/3 Tura Dish
Size: 176 x 325 x 80mm
Capacity: 2L
■ Tura Wood Effect / White TWD7713O
■ Tura Wood Effect / Black TWD7713B



1/4 Tura Dish
Size: 265 x 162 x 80mm
Capacity: 1.5L
■ Tura Wood Effect / White TWD7714O
■ Tura Wood Effect / Black TWD7714B



1/4 Tura Dish
Size: 176 x 162 x 80mm
Capacity: 1L
■ Tura Wood Effect / White TWD7716O
■ Tura Wood Effect / Black TWD7716B

TEXTURED WOOD EFFECT



PAINTED WOOD EFFECT



2/4 Tura Dish
Size: 530 x 162 x 80mm
Capacity: 3.5L
■ Teal TWD7724TL
■ Orange TWD7724OR
■ Blue TWD7724BL
■ Yellow TWD7724Y



1/2 Tura Dish
Size: 325 x 265 x 80mm
Capacity: 3.5L
■ Teal TWD7712TL
■ Orange TWD7712OR
■ Blue TWD7712BL
■ Yellow TWD7712Y



1/3 Tura Dish
Size: 176 x 325 x 80mm
Capacity: 2L
■ Teal TWD7713TL
■ Orange TWD7713OR
■ Blue TWD7713BL
■ Yellow TWD7713Y



1/4 Tura Dish
Size: 265 x 162 x 80mm
Capacity: 1.5L
■ Teal TWD7714TL
■ Orange TWD7714OR
■ Blue TWD7714BL
■ Yellow TWD7714Y



1/4 Tura Dish
Size: 176 x 162 x 80mm
Capacity: 1L
■ Teal TWD7716TL
■ Orange TWD7716OR
■ Blue TWD7716BL
■ Yellow TWD7716Y



TEAL



BLUE



ORANGE



YELLOW

INSERTS AND LIDS



White Tura Dish Insert
Size: 40mm Depth
■ 1L To Fit Tura Dish 1/3 GN (T7813) T7813
■ 850ml To Fit Tura Dish 1/4 GN (7814) T7814
■ 550ml To Fit Tura Dish 1/6 GN (7816) T7816



Clear Tura Dish Lid
Size: 33mm Height
■ To Fit Tura Dish 1/2 GN (7812) TC7912L
■ To Fit Tura Dish 1/4 GN (7814) TC7914L

GASTRONORM SIZES

Fits Gastronorm (GN)



WOOD TEXTURE



GASTRONORM



STACKABLE

USAGE

Fresh Food Counters

- Butchery / Meat Counter
- Fish & Seafood Counter
- Deli / Charcuterie Counter

Hospitality & Foodservice

- Buffet / Self-Serve Display
- Catering Buffet

WORKS WITH



TURA SERVING TRAY
Page 69



TURA SERVING TRAY
Page 69





TCN7716B

TWD77120

INSERTS AND LIDS



White Tura Dish Insert
Size: 40mm Depth
■ 1L To Fit Tura Dish 1/3 GN (T7813) **T7813**
■ 850ml To Fit Tura Dish 1/4 GN (7814) **T7814**
■ 550ml To Fit Tura Dish 1/6 GN (7816) **T7816**



Clear Tura Dish Lid
Size: 33mm Height
■ To Fit Tura Dish 1/2 GN (7812) **TC7912L**
■ To Fit Tura Dish 1/4 GN (7814) **TC7914L**

GASTRONORM SIZES

Fits Gastronorm (GN)



WOOD TEXTURE



GASTRONORM



STACKABLE

USAGE

Buffet Display

- Hotel
- Restaurant
- Caterers

Dinning

- Restaurant
- Poolside
- Hotel

WORKS WITH

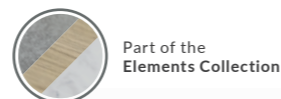

Part of the Elements Collection



URBAN SLAB
Page 53



CARRARA SLAB
Page 53

Tura Dish

Extensive colour and finish options allow Tura to adapt to any design direction. From marble and concrete effects to wood tones, the range offers consistency across large counters.

URBAN



1/2 Tura Dish
Size: 325 x 265 x 80mm
Capacity: 3.5L
■ Urban **TCN7712**



1/3 Tura Dish
Size: 176 x 325 x 80mm
Capacity: 2L
■ Urban **TCN7713**

URBAN TEXTURED CONCRETE EFFECT

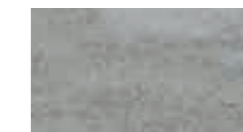

1/4 Tura Dish
Size: 265 x 162 x 80mm
Capacity: 1.5L
■ Urban **TCN7714**



1/6 Tura Dish
Size: 176 x 162 x 80mm
Capacity: 1L
■ Urban **TCN7716**

CARRARA



1/2 Tura Dish
Size: 325 x 265 x 80mm
Capacity: 3.5L
■ Carrara **TMA7712**



1/3 Tura Dish
Size: 176 x 325 x 80mm
Capacity: 2L
■ Carrara **TMA7713**

CARRARA TEXTURED MARBLE EFFECT



1/4 Tura Dish
Size: 265 x 162 x 80mm
Capacity: 1.5L
■ Carrara **TMA7714**



1/6 Tura Dish
Size: 172 x 162 x 80mm
Capacity: 1L
■ Carrara **TMA7716**





WORKS WITH



HPL 840 STEP
Page 23

ALTO TRAYS AND DISHES

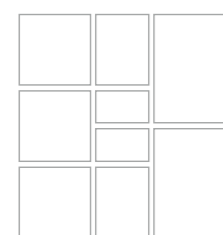

840 SYSTEM

ALTO 45° TRAY AND DISH

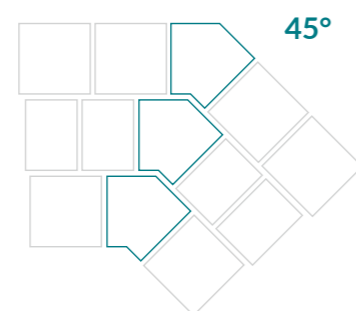

ALTO CORNER TRAYS AND DISHES

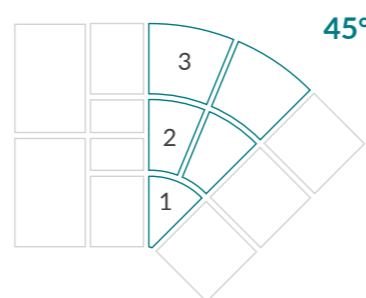

Aalto

Built to an 840 footprint, Aalto comes in five sizes that work together to maximise space, including corner formats that help complete awkward layouts. It allows operators to build structured, high-capacity displays without losing visual flow.



840 SYSTEM



INSERTS



ORGANIC SHAPES

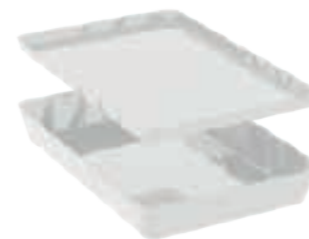

Aalto Tray
Size: 273 x 413 x 20mm
■ Black TB2445
■ White T2445

Aalto Dish
Size: 420 x 280 x 60mm
Capacity: 5.2L
■ Black TB2435
■ White T2435



Aalto Tray
Size: 273 x 273 x 20mm
■ Black TB2441
■ White T2441

Aalto Dish
Size: 280 x 280 x 60mm
Capacity: 3.4L
■ Black TB2431
■ White T2431



Aalto Tray
Size: 273 x 203 x 20mm
■ Black TB2442
■ White T2442

Aalto Dish
Size: 280 x 210 x 60mm
Capacity: 2.3L
■ Black TB2432
■ White T2432



Aalto Tray
Size: 273 x 133 x 20mm
■ Black TB2443
■ White T2443

Aalto Dish
Size: 280 x 140 x 60mm
Capacity: 1.6L
■ Black TB2433
■ White T2433



Aalto Tray
Size: 203 x 132 x 20mm
■ Black TB2444
■ White T2444

Aalto Dish
Size: 210 x 140 x 60mm
Capacity: 1.1L
■ Black TB2434
■ White T2434



Aalto 45° Tray
Size: 310 x 340 x 20mm
■ Black TB2449

Aalto 45° Dish
Size: 320 x 350 x 60mm
Capacity: 3.1L
■ Black TB2439

ALTO CORNER



Aalto Corner Tray 1
Size: 310 x 340 x 20mm
■ Black TB2446

Aalto Corner Dish 1
Size: 244 x 200 x 60mm
Capacity: 1.3L
■ Black TB2436



Aalto Corner Tray 2
Size: 270 x 198 x 20mm
■ Black TB2447

Aalto Corner Dish 2
Size: 282 x 210 x 60mm
Capacity: 1.8L
■ Black TB2437



Aalto Corner Tray 3
Size: 310 x 340 x 20mm
■ Black TB2448

Aalto Corner Dish 3
Size: 286 x 315 x 60mm
Capacity: 2.7L
■ Black TB2438





Mehndi

Decorative pattern brings instant focus to key dishes and adds immediate character to the counter. Compatible with circular stands and universal risers, Mehndi can be layered to build dynamic, eye-catching displays.



TEXTURED



LIGHTWEIGHT



LARGE SIZES

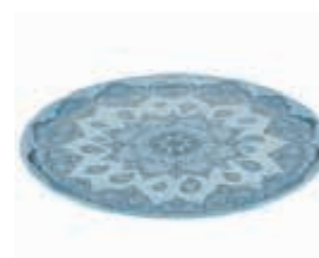

Mehndi Platter

Size: 350 x 350 x 15mm

- Blue TBL16315MEH
- Green TGY16315MEH
- Black TGY16315MEH
- Orange TOR16315MEH
- Purple TPU16315MEH



Mehndi Dish

Size: 350 x 350 x 30mm

- Blue TBL16316MEH
- Green TGY16316MEH
- Black TGY16316MEH
- Orange TOR16316MEH
- Purple TPU16316MEH



Mehndi Bowl

Size: 350 x 350 x 30mm
Capacity: 3.5L

- Blue TBL1631MEH
- Green TGY1631MEH
- Black TGY1631MEH
- Orange TOR1631MEH
- Purple TPU1631MEH



BLUE

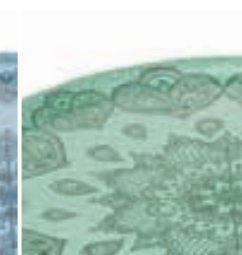

GREEN

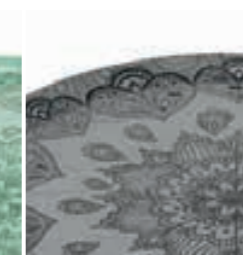

BLACK

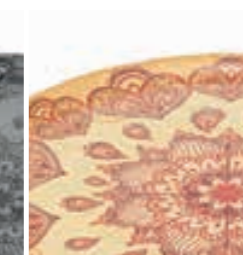

ORANGE

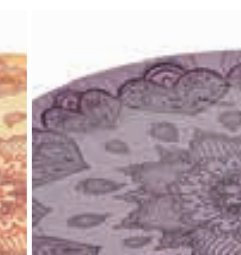

PURPLE

WORKS WITH



Domed Lid for 1631 (with optional handle)

Size: 350mm dia.

- Clear TC1631L

USAGE

Buffet Display

- Hotel
- Restaurant
- Caterers

Retail Display

- Butchers
- Deli
- Cheesmonger

WORKS WITH



Circular Buffet Stand
Page 27



Embossed Pedestal Stand
Page 17

WORKS WITH



Domed Lid for 1631 (with optional handle)

Size: 350mm dia.

- Clear TC1631L

BUFFET BROCHURE



RETAIL BROCHURE





TBL4612

TCM4613

Marl

Offering a speckled stoneware effect with professional durability. GN compatibility allows integration into counters, while reversible inserts reduce capacity or can create height. Stackability also supports efficient back of house storage.



DURABLE



ORGANIC TEXTURE



GASTRONORM



Marl 1/2 GN Size Insert
Size: 299 x 252 x 40mm
Capacity: 1.6L
Steel Blue TBL46124
Cream TCM46124



Marl 1/3 GN Size Insert
Size: 299 x 163 x 40mm
Capacity: 1L
Steel Blue TBL46134
Cream TCM46134



Marl 1/4 GN Size Insert
Size: 239 x 149 x 40mm
Capacity: 700ml
Steel Blue TBL46144
Cream TCM46144



Marl 1/2 GN Size Crock
Size: 325 x 265 x 80mm
Capacity: 3.7L
Steel Blue TBL4612
Cream TCM4612



Marl 1/3 GN Size Crock
Size: 325 x 176 x 80mm
Capacity: 2.3L
Steel Blue TBL4613
Cream TCM4613



Marl 1/4 GN Size Crock
Size: 265 x 162 x 80mm
Capacity: 1.6L
Steel Blue TBL4614
Cream TCM4614

USAGE

Buffet Display

- Hotel
- Restaurant
- Caterers

Retail Display

- Butchers
- Deli
- Cheesmonger

SIZES

Fits Gastronorm (GN) layout



DISPLAY DISHES AVAILABLE



MARL ROUND DISHES AVAILABLE ON PAGE 81



ANTI-SLIP SILICONE FEET



USE AS AN INSERT



USE THE INSERT AS A LID





TCM



WORKS WITH

Circular Buffet Stand
Page 27

USAGE

Buffet Display

- Hotel
- Restaurant
- Caterers

Retail Display

- Butchers
- Deli
- Cheesmonger

Tableware

- Restaurants
- Hotels
- Canteens

SPECKLED MELAMINE FINISHES



STEEL BLUE

CREAM

CHARCOAL GREY

MINIATURE AVAILABLE



Marl Ramekin
Size: 385 x 385 x 26mm
 Steel Blue TBL4610
 Cream TCM 4610
 Charcoal Grey TGY4610

MARL RETAIL CROCK
AVAILABLE ON PAGE 79

Marl

Soft tones and textured finishes introduce warmth without overpowering the food. A crafted aesthetic paired with melamine strength makes it suitable for luxury buffet and retail environments. A refined way to add character while maintaining resilience.



SPECKLED



ORGANIC TEXTURE



DURABLE



Marl Shallow Dish
Size: 385 dia x 26mm
 Steel Blue TBL4604
 Cream TCM4604
 Charcoal Grey TGY4604



Marl Deep Dish
Size: 385 dia x 72mm
 Steel Blue TBL4605
 Cream TCM4605
 Charcoal Grey TGY4605



Marl Deep Bowl
Size: 280 dia x 47mm
 Steel Blue TBL4603
 Cream TCM4603
 Charcoal Grey TGY4603



Marl Large Bowl
Size: 230 dia x 80mm
 Steel Blue TBL4607
 Cream TCM4607
 Charcoal Grey TGY4607



Marl Small Bowl
Size: 170 dia x 80mm
 Steel Blue TBL4606
 Cream TCM4606
 Charcoal Grey TGY4606



Marl Rectangular Platter
Size: 355 x 190 x 15mm
 Steel Blue TBL4609
 Cream TCM4609
 Charcoal Grey TGY4609



Marl Rectangular Plate
Size: 300 x 153 x 15mm
 Steel Blue TBL4608
 Cream TCM4608
 Charcoal Grey TGY4608



Marl Large Plate
Size: 280 dia x 16mm
 Steel Blue TBL4602
 Cream TCM4602
 Charcoal Grey TGY4602



Marl Small Plate
Size: 150 dia x 16mm
 Steel Blue TBL4601
 Cream TCM4601
 Charcoal Grey TGY4601

BUFFET BROCHURE



TABLEWARE BROCHURE





Carrara

Marble without the weight or fragility. Available in rounds and platters that pair with risers and stands to build layered displays. Carrara offers a premium finish that maintains practicality during heavy service.



MATT FINISH



DESIGNED IN UK



RISER OPTIONS



Carrara Rectangular Platter
Size: 400 x 300 x 14mm
■ White Carrara TMA9640



Carrara Rectangular Platter
Size: 300 x 200 x 14mm
■ White Carrara TMA9630

CARRARA TEXTURED MARBLE EFFECT



Carrara Round Platter
Size: 285 dia. x 14mm
■ White Carrara TMA3028



Carrara Round Platter
Size: 285 dia. x 14mm
■ Black Carrara TBMA3028

CARRARA TEXTURED BLACK MARBLE EFFECT



USAGE

Buffet Display

- Hotel
- Restaurant
- Caterers

Retail Display

- Butchers
- Deli
- Cheesmonger

WORKS WITH



Pedestal Stands
Page 17





ORGANIC SHAPES



CORNER OPTIONS



DESIGNED IN UK



USAGE

- Retail Display
- Butchers
- Deli
- Cheesmonger

WAVY PLATTER FOOTPRINT

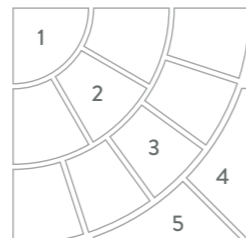
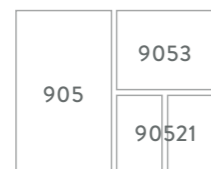

WAVY CORNER FOOTPRINT

- 1 - TB90551 (x1)
- 2 - TB90552 (x3)
- 3 - TB90553 (x5)
- 4 - TB90554 (x1)
- 5 - TB90555 (x1)

Wavy

Sculpted curves give Wavy trays a fluid, contemporary presence on the counter. The pieces can be combined to build complete corner displays that naturally draw the eye and anchor the layout.

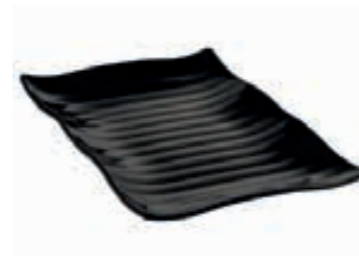

Wavy Platter
Size: 420 x 295 x 40mm
■ Black TB905

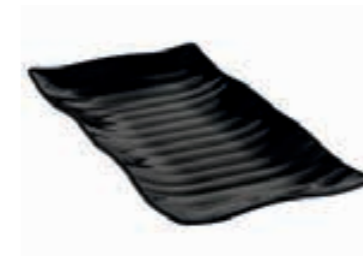

Wavy Platter
Size: 420 x 240 x 40mm
■ Black TB90500



Wavy Platter
Size: 390 x 285 x 40mm
■ Black TB90585

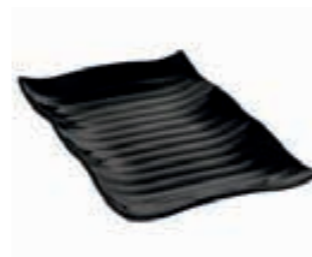

Wavy Platter
Size: 300 x 210 x 30mm
■ Black TB9053



Wavy Platter
Size: 150 x 210 x 30mm
■ Black TB90521



Wavy Platter
Size: 195 x 287 x 40mm
■ Black TB90595

Wavy Divider
Size: 175 x 50mm
■ Black TB90590

WAVY CORNER



Curved Wavy Platter
Size: 269 x 374 x 38mm
■ Black TB90551



Curved Wavy Platter
Size: 269 x 275 x 38mm
■ Black TB90552



Curved Wavy Platter
Size: 259 x 247 x 38mm
■ Black TB90553



Curved Wavy Platter
Size: 538 x 376 x 38mm
■ Black TB90555



Curved Wavy Platter
Size: 538 x 376 x 38mm
■ Black TB90554

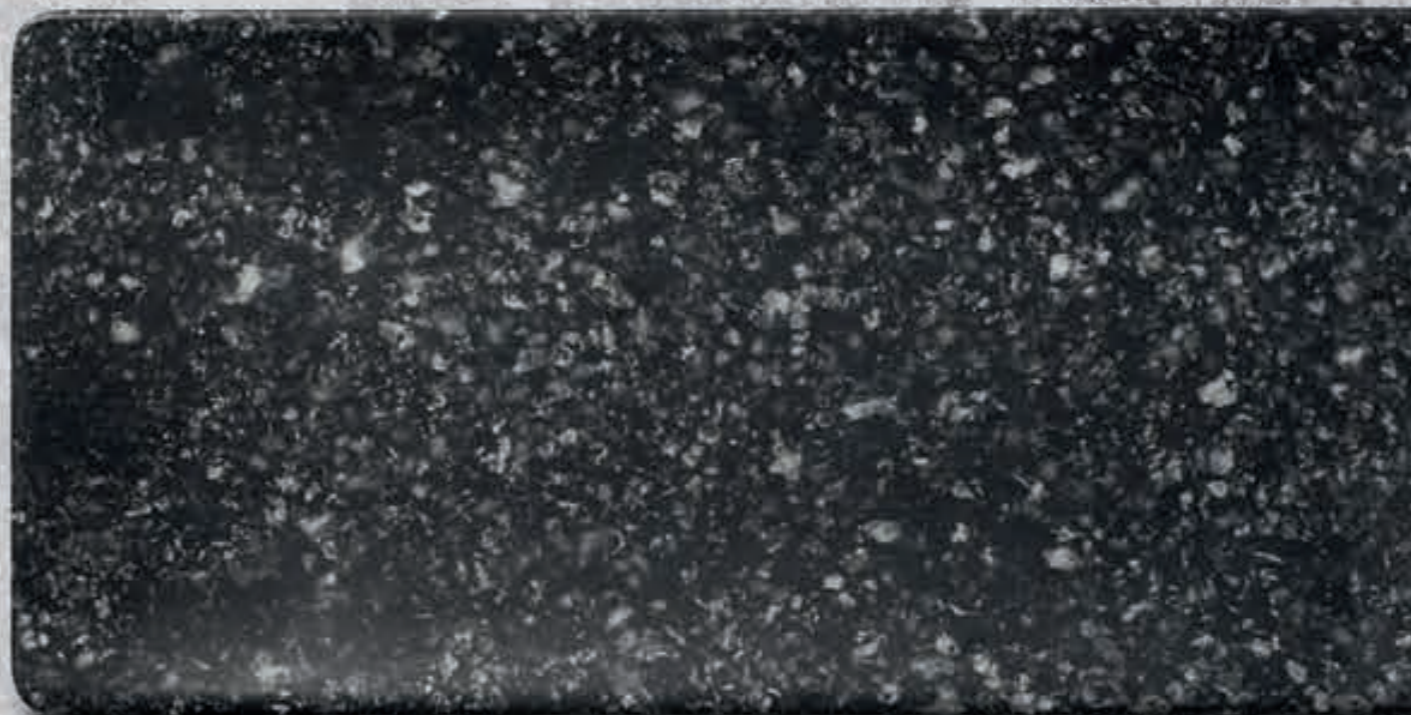
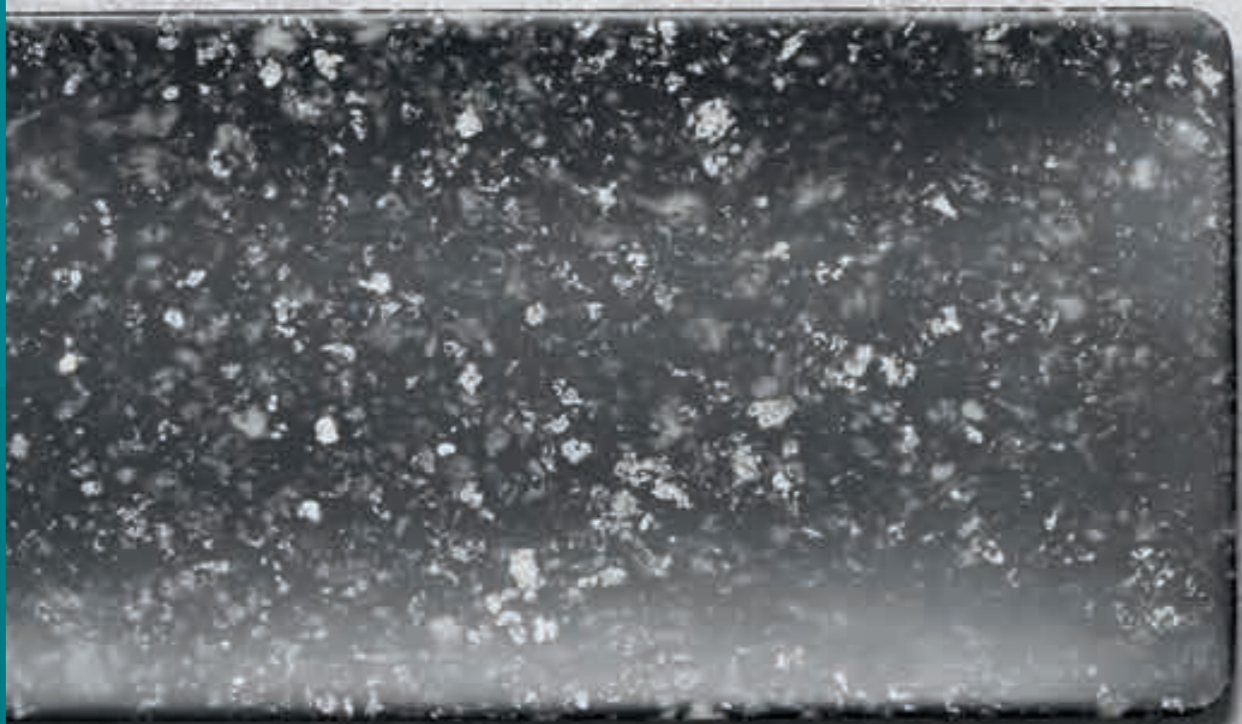

Dalebrook®



MATT BLACK



SPECKLED

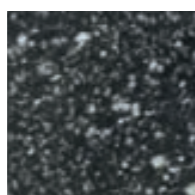

WORKS WITH

PAGE 27



Oxford

Minimalist platters in matte black or speckled finishes. Slightly raised edges reduce risk of spillage while silicone feet maintain grip on smooth surfaces. Oxford pairs with circular stands for contemporary tea or sharing displays.



SPECKLED



ORGANIC SHAPES



DESIGNED IN UK

BLACK



Oxford Platter
Size: 300 x 300 x 17mm
■ Black TB1441



Oxford Platter
Size: 300 x 200 x 17mm
■ Black TB1442



Oxford Platter
Size: 530 x 195 x 17mm
■ Black TB1440

SPECKLED



Oxford Platter
Size: 300 x 300 x 17mm
■ Speckled TGT1441



Oxford Platter
Size: 300 x 200 x 17mm
■ Speckled TGT1442



Oxford Platter
Size: 530 x 195 x 17mm
■ Speckled TGT1440





TEW7614

TEW7613

TEW7612

USAGE

Fresh Food Counters

- Butchery Counter
- Fish & Seafood
- Deli / Charcuterie

Fresh & Specialty

- Fresh Produce
- Salad Bar
- Self-Serve Display

GASTRONORM SIZES

Fits Gastronorm (GN)



Gastronorm (GN) is European standard for kitchenware tray container sizes that is commonly seen worldwide in the catering and professional food industry., as well in certain parts of the high-end consumer market.

1/1 GN	530 X 325mm
1/2 GN	325 X 265mm
1/3 GN	325 X 176mm
1/4 GN	265 X 162mm
1/6 GN	176 X 162mm
2/4 GN	530 X 162mm

Enamelware

Vintage charm recreated in scratch-resistant melamine. Lightweight construction supports high turnover environments without compromising aesthetic appeal.



GASTRONORM



SPACE SAVING



VARIETY OF FOODS

TRAYS



1/2 GN Enamelware Melamine Tray
Size: 325 x 265 x 30mm
Capacity:
■ Blue TEW7412



1/4 GN Enamelware Melamine Tray
Size: 265 x 162 x 30mm
■ Blue TEW7414

DISHES



1/2 GN Enamelware Melamine Dish
Size: 325 x 265 x 80mm
Capacity: 3.7L
■ Blue TEW7612



1/3 GN Enamelware Melamine Dish
Size: 176 x 325 x 80mm
Capacity: 2L
■ Blue TEW7613



1/4 GN Enamelware Melamine Dish
Size: 265 x 162 x 80mm
Capacity: 1.5L
■ Blue TEW7614

ACCESSORIES



Wavy Platter
Size: 100 x 100 x 85mm
Capacity: 400ml
■ Blue TEW7610



Wavy Platter
Size: 90 x 90 x 40mm
Capacity: 135ml
■ Blue TEW7609





Deluxe Gastro

GN-compatible trays that sit neatly into counter wells or lay flat on service tops. Their understated design lets food remain the focus. A dependable base for professional presentation.



GASTRONORM



DURABLE



LIDS

LIDS



1/1 GN PET Gastro Lid
Size: 540 x 340 x 65mm
Sold in packs of 25
■ Clear GN1/1L



1/2 GN PET Gastro Lid
Size: 275 x 340 x 65mm
Sold in packs of 25
■ Clear GN1/2L

TRAYS



1/1 GN Deluxe Gastro Dish
Size: 530 x 325 x 30mm
■ White T1870

DISHES



1/1 GN Deluxe Gastro Dish
Size: 530 x 325 x 65mm
Capacity: 5.5L
■ White T1865



1/2 GN Deluxe Gastro Dish
Size: 265 x 325 x 65mm
Capacity: 2.3L
■ White T1895



2/6 GN Deluxe Gastro Dish
Size: 176 x 162 x 100mm
Capacity: 900ml
■ White T1842

USAGE

Fresh Food Counters

- Butchery Counter
- Fish & Seafood
- Deli / Charcuterie

Fresh & Specialty

- Fresh Produce
- Salad Bar
- Self-Serve Display

GASTRONORM SIZES

Fits Gastronorm (GN)



Gastronorm (GN) is European standard for kitchenware tray container sizes that is commonly seen worldwide in the catering and professional food industry., as well in certain parts of the high-end consumer market.

1/1 GN	530 X 325mm
1/2 GN	325 X 265mm
1/3 GN	325 X 176mm
1/4 GN	265 X 162mm
1/6 GN	176 X 162mm
2/4 GN	530 X 162mm





Deluxe Thin Rim Gastro

Slim profile edges create a sharper, more refined outline. Available with lids to preserve freshness and assist with prep. Maintains GN functionality while offering a lighter visual presence.



GASTRONORM



LARGE SIZES



LIDS

LIDS



1/1 GN PET Gastro Lid
Size: 540 x 340 x 65mm
Sold in packs of 25
■ Clear GN1/1L



1/2 GN PET Gastro Lid
Size: 275 x 340 x 65mm
Sold in packs of 25
■ Clear GN1/2L



2/4 GN PET Gastro Lid
Size: 540 x 175 x 65mm
Sold in packs of 25
■ Clear GN11/2L



1/1 GN Deluxe Thin Rim Gastro Tray
Size: 530 x 325 x 30mm
Capacity: 2.1L
■ Black TB1470



1/2 GN Deluxe Thin Rim Gastro Tray
Size: 265 x 325 x 30mm
Capacity: 900ml
■ Black TB1490



2/4 GN Deluxe Thin Rim Gastro Tray
Size: 530 x 162 x 30mm
Capacity: 1L
■ Black TB1460

DISHES



1/1 GN Enamelware Melamine Dish
Size: 530 x 325 x 65mm
Capacity: 6.4L
■ Black TB1475



1/2 GN Enamelware Melamine Dish
Size: 265 x 325 x 65mm
Capacity: 2.7L
■ Black TB1495



2/4 GN Enamelware Melamine Dish
Size: 530 x 162 x 65mm
Capacity: 2.3L
■ Black TB1465

USAGE

Fresh Food Counters

- Butchery Counter
- Fish & Seafood
- Deli / Charcuterie

Fresh & Specialty

- Fresh Produce
- Salad Bar
- Self-Serve Display

GASTRONORM SIZES

Fits Gastronorm (GN)



Gastronorm (GN) is European standard for kitchenware tray container sizes that is commonly seen worldwide in the catering and professional food industry., as well in certain parts of the high-end consumer market.

1/1 GN	530 X 325mm
1/2 GN	325 X 265mm
1/3 GN	325 X 176mm
1/4 GN	265 X 162mm
1/6 GN	176 X 162mm
2/4 GN	530 X 162mm



Crescent

Curved forms connect product groups visually while saving space. Capacity variation introduces height without additional risers and when paired with Barrel Bowls you can create layered storytelling across the counter.

 <p>Large Deep Crescent Dish Size: 300 x 278 x 100mm Capacity: 5L ■ Black TB5631 ■ White T5631</p>	 <p>Large Shallow Crescent Dish Size: 300 x 278 x 63mm Capacity: 3L ■ Black TB5630 ■ White T5630</p>	 <p>Small Deep Crescent Dish Size: 200 x 185 x 100mm Capacity: 2L ■ Black TB5620 ■ White T5620</p>
 <p>Medium shallow Crescent Dish Size: 200 x 285 x 60mm Capacity: 1.4L ■ Black TB5622 ■ White T5622</p>	 <p>Small Shallow Crescent Dish Size: 180 x 60mm Capacity: 900ml ■ Black TB5680</p>	 <p>Low Bowl Size: 300 dia. x 65mm Capacity: 3L ■ Black TB3513 ■ White T3513</p>



IDEAL FOR RETAIL COUNTER CORNERS



STEPPED EFFECT WITH BARREL BOWL

WORKS WITH



Barrel Bowl 6.5L Set
Size: 300 x 278 x 63mm
Capacity: 6.5L
■ Black BB300 + BLB360

COUNTER SIDE PROFILE

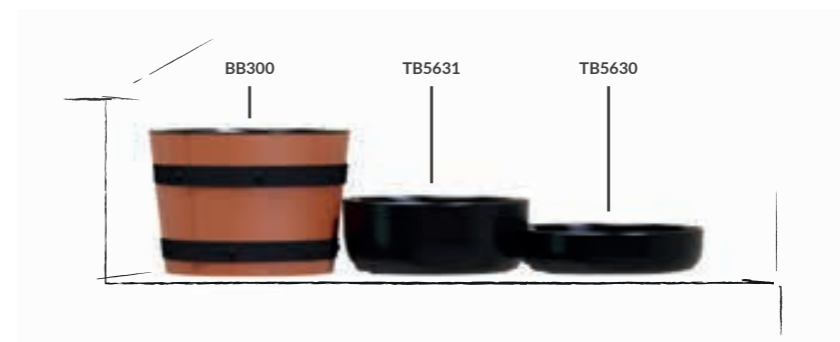

BUFFET BROCHURE

RETAIL BROCHURE





Classico

Timeless form that works across environments. classic rim detailing sharpens presentation while GN-compatible trays and dishes allow capacity control. Simple design that continues to perform service after service.



STACKABLE



GASTRONORM



DESIGNED IN UK

TRAY



1/2 GN Classico Tray
Size: 325 x 265 x 30mm
■ Black TB1290



1/4 GN Classico Tray
Size: 265 x 162 x 30mm
■ Black TB1280

DISH



1/2 GN Classico Dish
Size: 325 x 265 x 90mm
Capacity: 4L
■ Black TB1292



1/4 GN Classico Dish
Size: 265 x 162 x 90mm
Capacity: 2L
■ Black TB1282



1/6 GN Classico Dish
Size: 176 x 162 x 90mm
Capacity: 1L
■ Black TB1242

USAGE

Fresh Food Counters

- Butchery Counter
- Fish & Seafood
- Deli / Charcuterie

Fresh & Specialty

- Fresh Produce
- Salad Bar
- Self-Serve Display

GASTRONORM SIZES

Fits Gastronorm (GN)



Gastronorm (GN) is European standard for kitchenware tray container sizes that is commonly seen worldwide in the catering and professional food industry., as well in certain parts of the high-end consumer market.

1/1 GN	530 X 325mm
1/2 GN	325 X 265mm
1/3 GN	325 X 176mm
1/4 GN	265 X 162mm
1/6 GN	176 X 162mm
2/4 GN	530 X 162mm





DOVER LAYOUT

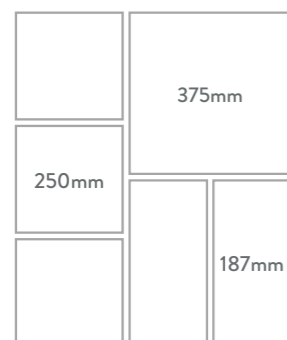

WORKS WITH

Chrome Plated Three Tier
Angled Wire Stand
Size: 430 x 330 x 710mm
■ Chrome TCP1799

Stand Fits

- T1777
- T1778
- T1779



USAGE

Bakery & Café

- Patisserie Counter
- Cake Display
- Coffee Shop Display

Fresh & Specialty

- Fresh Produce
- Salad Bar
- Self-Serve Display

Dover

Clean lines meet sculptural form in the Dover range. Its shape builds presence on the counter, especially when paired with the coordinating 3-tiered stand to introduce height. Strong, food-grade construction keeps displays steady through service.



STACKABLE



DESIGNED IN UK



LARGE SIZES

TRAY



Dover Tray
Size: 375 x 375 x 30mm
■ White T1778



Dover Tray
Size: 250 x 250 x 30mm
■ White T1776
■ Black TB1776



Dover Tray
Size: 375 x 187 x 30mm
■ White T1764

DISH



Dover Dish
Size: 375 x 375 x 140mm
Capacity: 5.4L
■ White T1779



Dover Dish
Size: 375 x 375 x 90mm
Capacity: 5L
■ White T1777



Dover Dish
Size: 290 x 290 x 80mm
Capacity: 2.5L
■ White T1781



Dover Dish
Size: 250 x 250 x 90mm
Capacity: 2L
■ White T1775
■ Black TB1775



Dover Dish
Size: 250 x 250 x 60mm
Capacity: 1L
■ White T1763



Dover Pot
Size: 150 x 100 x 80mm
Capacity: 700ml
■ White T1790
■ Black TB1790







Dalebrook®

Dishes

 56 Trafalgar

 61 Frame

 71 - 73 Tura Dish

 75 Aalto

 78 - 81 Marl

 91 Enamelware

 93 Deluxe Gastro

 95 Thin Rim Gastro

 99 Classico

 101 Dover

 105 Mineral

 109 Mino

 111 Fleur

 113 Chunky

 117 Kata

 121 Nordic

 129 Pigment

 141 Ore



Mineral

A matt surface scattered with subtle glossy particles reflects light and brings vibrancy to the food. It introduces a luxury feel to buffet and counter environments without the fragility of ceramic.

DISH



Mineral Dish Large
Size: 420 x 280 x 50mm
Capacity: 3.3L
■ Black TB2903



Mineral Dish Square
Size: 280 x 280 x 50mm
Capacity: 2L
■ Black TB2902



Mineral Dish Medium
Size: 280 x 210 x 50mm
Capacity: 1.5L
■ Black TB2901



840 SYSTEM



ORGANIC SHAPES



ORGANIC TEXTURE

840 SYSTEM

Fits within a common 840mm deep counter space. Items in this footprint can be used both horizontally or vertically for multiple combinations.

LARGE	280 X 420mm
SQUARE	280 X 280mm
MEDIUM	280 X 210mm
SMALL	280 X 140mm
X SMALL	140 X 210mm







840 SYSTEM

Fits within a common 840mm deep counter space. Items in this footprint can be used both horizontally or vertically for multiple combinations.

LARGE	280 X 420 MM
SQUARE	280 X 280MM
MEDIUM	280 X 210MM
SMALL	280 X 140MM

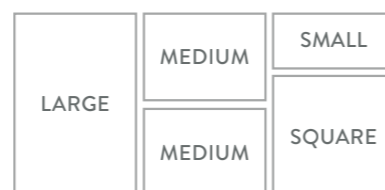

840 SYSTEM

840

ORGANIC TEXTURE



ORGANIC SHAPES



Mino

Textured surface with an 840 footprint that balances impact and efficiency. Wider silicone feet increase grip and stability in high traffic settings. A crafted look backed by professional durability.

DEEP DISH



Mino Deep Dish
Size: 420 x 280 x 60mm
Capacity: 4.55L
■ Black TB8311



Mino Deep Dish Medium
Size: 210 x 280 x 60mm
Capacity: 2.2L
■ Black TB8312



Mino Square Deep Dish
Size: 280 x 280 x 60mm
Capacity: 3.05L
■ Black TB8323



Mino Deep Dish Small
Size: 280 x 140 x 60mm
Capacity: 1.3L
■ Black TB8313

DISH



Mino Dish Large
Size: 420 x 280 x 30mm
■ Black TB8411



Mino Dish Medium
Size: 210 x 280 x 30mm
■ Black TB8412



Mino Square Dish
Size: 280 x 280 x 30mm
■ Black TB8423



Mino Dish Small
Size: 280 x 140 x 30mm
■ Black TB8413





Fleur

A distinctive rim gives Fleur an expressive outline on the counter. Available in a variety of colours, each dish fits a GN footprint and includes silicone feet for stability. A practical way to introduce softness and shape to structured layouts.



INSERT



1/4 GN Fleur Insert
Size: 265 x 162 x 58mm
Capacity: 1.1L
White T4514

1/4 GN Fleur Shallow Insert
Size: 270 x 160 x 45mm
Capacity: 700ml
White T4414

1/6 GN Fleur Insert
Size: 176 x 162 x 58mm
Capacity: 700ml
White T4516

DISH



1/2 GN Fleur
Size: 325 x 265 x 100mm
Capacity: 4L
White T3312
Black TB3312
Black/White TB3312W
Blue TBL3312W
Lime TLG3312W
Green TG3312W
Red TR3312W
Yellow TY3312W

1/4 GN Fleur
Size: 325 x 265 x 100mm
Capacity: 2L
White T3314
Black TB3314
Black/White TB3314W
Blue TBL3314W
Lime TLG3314W
Green TG3314W
Red TR3314W
Yellow TY3314W

1/6 GN Fleur
Size: 325 x 265 x 100mm
Capacity: 1L
White T3316
Black TB3316
Black/White TB3316W
Blue TBL3316W
Lime TLG3316W
Green TG3316W
Red TR3316W
Yellow TY3316W





TR4313

TB4314

USAGE

Fresh & Specialty

- Fresh Produce
- Salad Bar
- Self-Serve Display

INSERT

Use insert to reduce capacity and keep food rotating. Available as black and white options.



Chunky

Built for busy counters, Chunky dishes create a full and abundant display. Silicone feet keep them secure, while compatible inserts help manage portion control and reduce food waste. Strong form and generous proportions suit salad bars and fresh food environments.



SILICONE FEET



DESIGNED IN UK



INSERTS

INSERT



Chunky Insert
Size: 325 x 265 x 100mm
■ Black TB5312
■ White TPO5312



Chunky Insert
Size: 325 x 265 x 100mm
■ Black TB5313
■ White TPO5313



Chunky Insert
Size: 325 x 265 x 100mm
■ Black TB5314
■ White TPO5314

DISH



Chunky
Size: 325 x 265 x 100mm
Capacity: 3.2L
■ White TPO4312
■ Black TB4312
■ Lime TLG4312
■ Red TR4312



Chunky
Size: 325 x 265 x 100mm
Capacity: 2L
■ White TPO4313
■ Black TB4313
■ Lime TLG4313
■ Red TR4313



Chunky
Size: 325 x 265 x 100mm
Capacity: 1.5L
■ White TPO4314
■ Black TB4314
■ Lime TLG4314
■ Red TR4314



Chunky
Size: 130 x 81 x 100mm
Capacity: 600ml
■ Black TB4315SF
■ White TPO4315SF



Dalebrook®





NIMBLE DISPLAY STANDS
PAGE 118



Kata











A multifunctional dish that shifts between vessel and platform. Use upright for added capacity or flip it to use as a platter. Kata adds flexibility offering a dynamic platform to showcase a wide variety of food types.



SPECKLED

REVERSIBLE

LARGE RANGE

 <p>Kata Size: 130 x 175 x 100mm Capacity: 1.5L <ul style="list-style-type: none"> ■ Speckled Black TKT4214 ■ Speckled White TKTW4214 ■ Noir TB4214 ■ Blanc TW4214 </p>	 <p>Kata Size: 175 x 260 x 100mm Capacity: 3.2L <ul style="list-style-type: none"> ■ Speckled Black TKT4212 ■ Speckled White TKTW4212 ■ Noir TB4212 ■ Blanc TW4212 </p>	 <p>Kata Size: 345 x 260 x 100mm Capacity: 6.7L <ul style="list-style-type: none"> ■ Speckled Black TKT4216 ■ Speckled White TKTW4216 ■ Noir TB4216 ■ Blanc TW4216 </p>	 <p>Kata Size: 175 x 520 x 100mm Capacity: 6.65L <ul style="list-style-type: none"> ■ Speckled Black TKT4218 ■ Speckled White TKTW4218 ■ Noir TB4218 ■ Blanc TW4218 </p>
 <p>Kata Size: 130 x 175 x 70mm Capacity: 850ml <ul style="list-style-type: none"> ■ Speckled Black TKT4224 ■ Speckled White TKTW4224 ■ Noir TB4224 ■ Blanc TW4224 </p>	 <p>Kata Size: 175 x 260 x 70mm Capacity: 1.95L <ul style="list-style-type: none"> ■ Speckled Black TKT4222 ■ Speckled White TKTW4222 ■ Noir TB4222 ■ Blanc TW4222 </p>	 <p>Kata Size: 345 x 260 x 70mm Capacity: 4.2L <ul style="list-style-type: none"> ■ Speckled Black TKT4226 ■ Speckled White TKTW4226 ■ Noir TB4226 ■ Blanc TW4226 </p>	 <p>Kata Size: 175 x 520 x 70mm Capacity: 4.2L <ul style="list-style-type: none"> ■ Speckled Black TKT4228 ■ Speckled White TKTW4228 ■ Noir TB4228 ■ Blanc TW4228 </p>
 <p>Kata Size: 130 x 175 x 40mm Capacity: 350ml <ul style="list-style-type: none"> ■ Speckled Black TKT4234 ■ Speckled White TKTW4234 ■ Noir TB4234 ■ Blanc TW4234 </p>	 <p>Kata Size: 175 x 260 x 40mm Capacity: 750ml <ul style="list-style-type: none"> ■ Speckled Black TKT4232 ■ Speckled White TKTW4232 ■ Noir TB4232 ■ Blanc TW4232 </p>	 <p>Kata Size: 345 x 260 x 40mm Capacity: 1.95L <ul style="list-style-type: none"> ■ Speckled Black TKT4236 ■ Speckled White TKTW4236 ■ Noir TB4236 ■ Blanc TW4236 </p>	 <p>Kata Size: 175 x 520 x 40mm Capacity: 1.75L <ul style="list-style-type: none"> ■ Speckled Black TKT4238 ■ Speckled White TKTW4238 ■ Noir TB4238 ■ Blanc TW4238 </p>
 <p>Kata Size: 520 x 346 x 70mm Capacity: 8.9L <ul style="list-style-type: none"> ■ Speckled Black TKT4220 ■ Speckled White TKTW4220 ■ Noir TB4220 ■ Blanc TW4220 </p>			

BUFFET BROCHURE

RETAIL BROCHURE



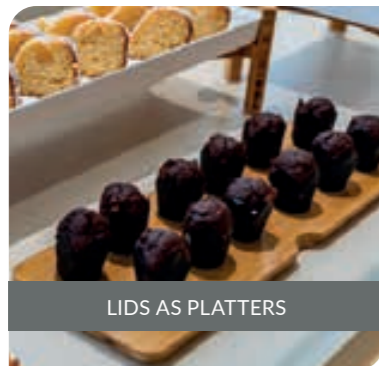

LIDS AS PLATTERS



KATA AND NIMBLE ARE REVERSIBLE



MULTI TIERED DISPLAYS

Nimble

The Nimble riser is a versatile and convenient solution for retailers or hotels looking to enhance their buffet displays. Crafted from bamboo, Nimble risers introduce natural warmth and elevated presentation. Developed to pair with Kata, they add depth and height variation to luxury displays.



REVERSIBLE



FLAT PACKED



BAMBOO



Kata is available in four different finishes. See Page 117 for full range of Kata





Nordic

Matt black surfaces and clean geometry bring a sharp modern tone to the counter. Inserts can double as risers to introduce layered presentation without additional components. Durable construction makes Nordic reliable for butcher and retail settings.

TRAY



Nordic Tray
Size: 260 x 450 x 18mm
■ Black TB4524M



Nordic Tray
Size: 260 x 300 x 18mm
■ Black TB4523M



Nordic Tray
Size: 260 x 150 x 18mm
■ Black TB4528M

DISH



Nordic Dish
Size: 325 x 265 x 100mm
Capacity: 2.5L
Works with: Inert TB4525M
■ Black TB4525M



Nordic Insert
Size: 325 x 265 x 100mm
Capacity: 1.5L
Works with: Use as insert for TB4525M
■ Black TB4526M



Nordic Dish
Size: 325 x 265 x 100mm
Capacity: 1L
■ Black TB4527M

PUSH TO REMOVE INSERT



TRAY AS A COVER

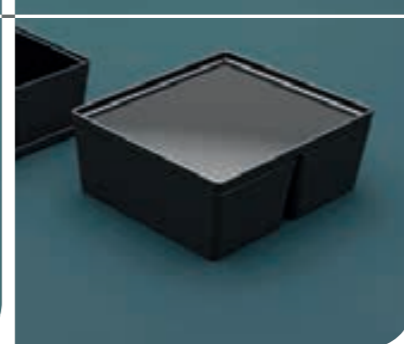

INSERT AS A RISER OR COVER



SILICONE FEET



DESIGNED IN UK



INSERTS





Dalebrook®

Bowls



45

Talon



77

Mehndi



81

Marl



97

Crescent



125 - 127 Casablanca



129

Pigment



131

Urban



133

Ripple



133

Mezze



134 - 135 Barrel



153

Glazz



175

Mineral



Casablanca

Distressed crackle finishes and bold colour bring character to your display. The ceramic-inspired surface adds richness while melamine construction maintains resilience. The obvious partner for vibrant menus and world cuisine.



LARGE RANGE



TEXTURED



DESIGNED IN UK



Casablanca Dish
Size: 420 x 420 x 70mm
Capacity: 6L

- Blue TBL1630
- Green TG1630
- Grey TGY1630
- Orange TOR1630
- Red TR1630
- White TW1630

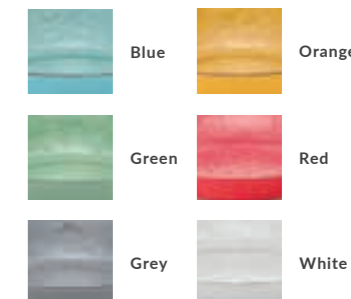

Casablanca Bowl
Size: 350 x 350 x 70mm
Capacity: 3.5L

- Blue TBL1631
- Green TG1631
- Grey TGY1631
- Orange TOR1631
- Red TR1631
- White TW1631



Casablanca Platter
Size: 350 x 350 x 30mm
can be used as insert for 1631

- Blue TBL16316
- Green TG16316
- Grey TGY16316
- Orange TOR16316
- Red TR16316
- White TW16316



Casablanca Bowl
Size: 210 x 210 x 70mm
Capacity: 1.3L

- Blue TBL1637
- Green TG1637
- Grey TGY1637
- Orange TOR1637
- Red TR1637
- White TW1637



Casablanca Salad Dish
Size: 210 x 210 x 29mm
Capacity: 500ml
can be used as insert for 1637

- Blue TBL1639
- Green TG1639
- Grey TGY1639
- Orange TOR1639
- Red TR1639
- White TW1639



Casablanca Bowl
Size: 190 x 190 x 50mm
Capacity: 600ml

- Blue TBL1632
- Green TG1632
- Grey TGY1632
- Orange TOR1632
- Red TR1632
- White TW1632



Casablanca Salad Dish
Size: 190 x 190 x 27mm
Capacity: 345ml
can be used as insert for 1632

- Blue TBL1635
- Green TG1635
- Grey TGY1635
- Orange TOR1635
- Red TR1635
- White TW1635

USAGE

Buffet Display

- Hotel
- Restaurant
- Caterers

Tableware

- Poolside
- Restaurant
- Canteen

WORKS WITH



Domed Lid for 1631 (with optional handle)
Size: 350mm dia.
■ Clear TC1631L



WITHOUT HANDLE

WITH HANDLE



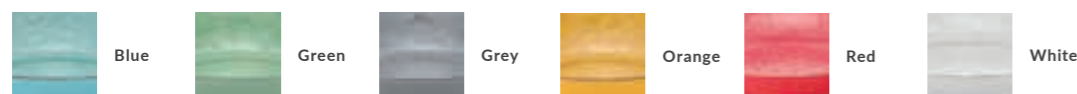

USAGE

Buffet Display

- Hotel
- Restaurant
- Caterers

Dinning

- Restaurant
- Poolside
- Hotel

WORKS WITH



Embossed Pedestal Stand
Page 17



Twist Riser
Page 17

MINIATURE



Casablanca Ramekin
Size: 86 x 86 x 30mm
Capacity: 60ml
 Blue TBL1660
 Green TG1660
 Grey TGY1660
 Orange TOR1660
 Red TR1660
 White T1660

Casablanca

Distressed crackle finishes and bold colour bring character to your display. The ceramic-inspired surface adds richness while melamine construction maintains resilience. The obvious partner for vibrant menus and world cuisine.



LARGE RANGE



TEXTURED



DESIGNED
IN UK



Casablanca Oval Dish
Size: 420 x 280 x 70mm
Capacity: 3.8L
 Blue TBL16312
 Green TG16312
 Grey TGY16312
 Orange TOR16312
 Red TR16312
 White TW16312



Casablanca Oval Low Dish
Size: 420 x 280 x 40mm
Capacity: 2.5L
can be used as insert for 16312
 Blue TBL16311
 Green TG16311
 Grey TGY16311
 Orange TOR16311
 Red TR16311
 White TW16311



Casablanca Oval Dish
Size: 210 x 280 x 70mm
Capacity: 1.5L
 Blue TBL1638
 Green TG1638
 Grey TGY1638
 Orange TOR1638
 Red TR1638
 White TW1638



Casablanca Oval Low Dish
Size: 210 x 280 x 40mm
Capacity: 800ml
can be used as insert for 1638
 Blue TBL16314
 Green TG16314
 Grey TGY16314
 Orange TOR16314
 Red TR16314
 White TW16314



Casablanca Large Plate
Size: 280 x 280 x 20mm
 Blue TBL1633
 Green TG1633
 Grey TGY1633
 Orange TOR1633
 Red TR1633
 White TW1633



Casablanca Small Plate
Size: 230 x 230 x 17mm
 Blue TBL1634
 Green TG1634
 Grey TGY1634
 Orange TOR1634
 Red TR1634
 White TW1634



Casablanca Rice Bowl
Size: 130 x 130 x 60mm
Capacity: 230ml
 Blue TBL1636
 Green TG1636
 Grey TGY1636
 Orange TOR1636
 Red TR1636
 White TW1636





TEXTURED



ORGANIC SHAPES



LARGE SIZES



ORGANIC SHAPES

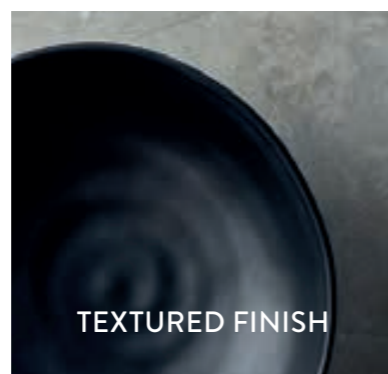

TEXTURED FINISH

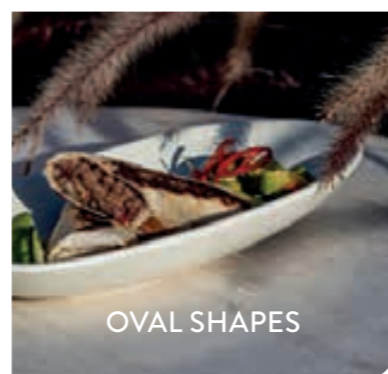

OVAL SHAPES



Square Pigment fits Loom Base
Easy twist to lock



Loom Cake Pedestal Base
Size: 110 dia. x 111mm
White T1404



Loom Cake Pedestal Base
Size: 110 dia. x 61mm
White T1403



Loom Cake Pedestal Base
Size: 110 dia. x 17mm
White T1405

Pigment

Organic contours and tactile matt finishes echo hand-thrown ceramics. Sculptural shapes bring depth to displays while remaining practical for high traffic service. Pigment balances artistry with durability.



Pigment Bowl
Size: 338 x 338 x 92mm
Capacity: 4L
Noir TB4707
Parchment TCM4707
Aqua TAQ4707
Agate Grey TGY4707
Himalayan TPK4707



Pigment Bowl
Size: 312 x 312 x 84mm
Capacity: 3.2L
Noir TB4706



Pigment Oval Bowl
Size: 240 x 200 x 88mm
Capacity: 1.2L
Noir TB4705
Parchment TCM4705
Aqua TAQ4705
Size: 170 x 140 x 60mm
Capacity: 380ml
Noir TB4704
Parchment TCM4704
Aqua TAQ4704



Pigment Long Bowl
Size: 325 x 140 x 40mm
Capacity: 700ml
Noir TB4703
Parchment TCM4703
Aqua TAQ4703



Pigment Square Dish
Size: 250 x 250 x 65mm
Capacity: 2L
Compatible with: Loom Pedestal Bases
Noir TB472525
Parchment TCM472525
White T472525



Pigment Square Dish
Size: 200 x 200 x 60mm
Capacity: 1L
Compatible with: Loom Pedestal Bases
Noir TB472020
Parchment TCM472020
White T472020



Pigment Oval Dish
Size: 530 x 325 x 70mm
Capacity: 5L
Noir TB4773
Parchment TCM4773
Aqua TAQ4773
Agate Grey TGY4773



Pigment Oval Dish
Size: 420 x 280 x 70mm
Capacity: 3.4L
Noir TB4772
Parchment TCM4772
Aqua TAQ4772
Agate Grey TGY4772



Pigment Oval Dish
Size: 280 x 210 x 70mm
Capacity: 1.5L
Noir TB4771
Parchment TCM4771
Aqua TAQ4771
Agate Grey TGY4771



Pigment Oval Tray
Size: 530 x 325 x 30mm
Noir TB4776
Parchment TCM4776
Aqua TAQ4776
Agate Grey TGY4776



Pigment Oval Tray
Size: 420 x 280 x 30mm
Noir TB4775
Parchment TCM4775
Aqua TAQ4775
Agate Grey TGY4775



Pigment Oval Tray
Size: 280 x 210 x 30mm
Noir TB4774
Parchment TCM4774
Aqua TAQ4774
Agate Grey TGY4774



Urban Bowls

Concrete-inspired finishes introduce an industrial character. Suitable for both fresh food counters and buffet service, they provide a strong visual base for contemporary menus.



TEXTURED FINISH



PART OF A RANGE



DESIGNED IN UK



Urban Large Bowl
Size: 280 dia. x 120mm
Capacity: 3.2L
■ Urban TCN9261



Urban Medium Bowl
Size: 245 dia. x 105mm
Capacity: 2L
■ Urban TCN9260



Urban Small Bowl
Size: 178 dia. x 80mm
Capacity: 1.22L
■ Urban TCN9262



TEXTURE

Urban matt textured concrete effect

WORKS WITH



URBAN SLAB
Page 53

BUFFET BROCHURE



RETAIL BROCHURE





Ripple

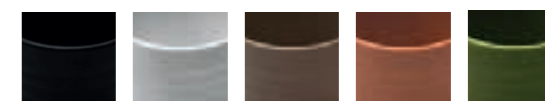

ORGANIC SHAPES



MATT FINISH



DESIGNED IN UK



Ripple Large Bowl
Size: 250 dia. x 150mm
Capacity: 4.5L
■ Black TB1555
■ White T1555



Ripple Low Bowl
Size: 200 dia. x 70mm
Capacity: 1.3L
■ Black TB1556
■ White T1556
■ Stone TST1556



Ripple Low Bowl
Size: 140 dia. x 35mm
Capacity: 280ml
■ Black TB1554



Ripple Pot
Size: 110 dia. x 90mm
Capacity: 350ml
■ Black TB1552
■ White T1552
■ Stone TST1552



Ripple Ramekin
Size: 70 dia. x 50mm
Capacity: 75ml
■ Black TB1551
■ White T1551
■ Stone TST1551
■ Terracotta TT1551
■ Green TG1551

Subtle surface movement adds texture without overwhelming the food. The flowing design helps soften displays and introduces visual rhythm.



Mezze



MATT FINISH



PERFECT FOR OLIVES



INSERT



Mezze Insert
Size: 188 x 188 x 43mm
Capacity: 1L
■ Black TB2921



Mezze Bowl
Size: 200 x 200 x 150mm
Capacity: 3.3L
■ Black TB2920M



Mezze Insert
Size: 188 x 188 x 43mm
Capacity: 1L
■ Terracotta TT2921



Mezze Bowl
Size: 200 x 200 x 150mm
Capacity: 3.3L
■ Terracotta TT2920M

Mezze bowls bring rustic warmth to counters without the fragility of traditional terracotta. Ideal for antipasti, olives and salad toppings, they help build layered, abundant displays. Crafted from chip-resistant, food-safe melamine, they maintain quality and hygiene through repeated professional use.



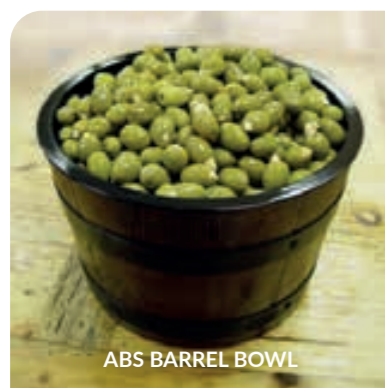

ABS Barrel Bowl
Size: 245 dia. x 150mm
Capacity: 5.4L
■ Brown BB352



Barrel Bowl Liner
Size: 250 dia. x 125mm
Capacity: 3.9L
■ Black BLB352



Barrel Bowl Set
Capacity: 3.9L
(BB352 + BLB352)



ABS Barrel Bowl
Size: 260 dia. x 195mm
Capacity: 7.5L
■ Brown BB353



Barrel Bowl Liner
Size: 265 dia. x 170mm
Capacity: 5.7L
■ Black BLB353



Barrel Bowl Set
Capacity: 5.7L
(BB353 + BLB353)

Barrel

Mixed capacities and optional melamine liners allow smaller portions to look abundant while keeping control of stock. Ideal for deli counters, olive presentation or even beachside ice buckets, they add rustic texture with professional practicality.



Tura Barrel Bowl
Size: 265 dia. x 200mm
Capacity: 6.5L
■ Tura TWD300



Tura Barrel Bowl
Size: 211 dia. x 160mm
Capacity: 3L
■ Tura TWD351



Tura Barrel Bowl Insert for TWD351
Size: 211 dia. x 70mm
Capacity: 1.5L
■ White BLW351



ABS Barrel Bowl
Size: 300 dia. x 195mm
Capacity: 10L
■ Brown BB300



Barrel Bowl Liner
Size: 303 dia. x 170mm
Capacity: 8L
■ Black BLB355



Barrel Bowl Set
Capacity: 8L
(BB300 + BLB355)

LARGE



ABS Barrel Bowl
Size: 300 dia. x 195mm
Capacity: 10L
■ Brown BB300



Barrel Bowl Liner
Size: 307 dia. x 150mm
Capacity: 6.5L
■ Black BLB360



Barrel Bowl Set
Capacity: 6.5L
(BB300 + BLB360)

MEDIUM



ABS Barrel Bowl
Size: 300 dia. x 195mm
Capacity: 10L
■ Brown BB300



Barrel Bowl Liner
Size: 307 dia. x 90mm
Capacity: 4.5L
■ Black BLB350



Barrel Bowl Set
Capacity: 4.5L
(BB300 + BLB350)

SMALL



DURABLE



DISHWASHER SAFE



FOOD GRADE

WORKS WITH



Barrel Bowl Liner / Insert
Size: 307mm dia
■ 4.5L BLB350
■ 6.5L BLB360

WORKS WITH:

Poly Wicker Willow Barrel Bowl
Size: 325 dia. x 205mm
■ Willow W350



Chrome Plated 3 Tier Angled Stand
Size: 430 x 330 x 710mm
■ Chrome TCP1799

WORKS WITH:

Poly Wicker Willow Angled Basket
Size: 337 x 331 x 55-110mm
■ Willow W1799



Use 3x Chunky Crock 2L
Size: 162 x 173 x 100mm
■ Black TB4313

WORKS WITH:

Poly Wicker Willow Rectangular Basket
Size: 550 x 195 x 110mm
■ Willow W430

Poly Wicker

Food-grade woven baskets that combine natural texture with professional durability. Lightweight yet strong, they maintain shape during service. Ideal for bread, produce and artisanal food presentation.



Polly Wicker Rectangular Basket
Size: 550 x 195 x 110mm
Works with: Fits 3x Chunky Crock TB4313
■ Willow W430



84G
Polly Wicker Rectangular Basket
Size: 420 x 280 x 50mm
■ Willow W1071



GN
1/2 GN Polly Wicker Rectangular Basket
Size: 325 x 265 x 50mm
■ Willow W1012



84G
Poly Wicker Willow Square Basket
Size: 280 x 280 x 50mm
■ Willow W1072



84G
Poly Wicker Willow Square Basket
Size: 210 x 210 x 50mm
■ Willow W1074



84G
Polly Wicker Rectangular Basket
Size: 210 x 280 x 50mm
■ Willow W1073



Poly Wicker Willow Barrel Bowl
Size: 325 dia. x 205mm
Works with: Barrel Bowl Liner BLB350 / BLB360
■ Willow W350



Poly Wicker Willow Round Basket
Size: 230 dia. x 80mm
■ Willow W251



Poly Wicker Willow Round Basket
Size: 180 dia. x 95mm
■ Willow W250



Poly Wicker Willow Angled Basket
Size: 337 x 331 x 55-110mm
Works with: Three Tier Stand TCP1799
■ Willow W1799

MANHATTAN BASKETS:

See page 31 for baskets designed to work with our Manhattan Z Stands

BUFFET BROCHURE



RETAIL BROCHURE





Hot Counter



141 Ore



141 Ore Round



143 Stainless Steel



145 Silicone Utensils



HOT COUNTER



GREBLON COATING



GASTRONORM



STACKABLE



SPACE SAVING HANDLES



GASTRO GRID SYSTEM



INDUCTION



HOB



NO NAKED FLAME



OVEN USE



GREBLON COATING



STACKABLE

Ore

A stainless-steel body with Greblon coating makes Ore induction compatible and suitable for hot counters. The corner handles are shaped to prevent tray clashes keeping layouts organised. Clean lines bring modern clarity to heated service areas.



1/1 GN Ore Dish
Size: 325 x 265 x 70mm
Capacity: 11L
■ Black TSSB2611



2/4 GN Ore Dish
Size: 162 x 530 x 70mm
Capacity: 6L
■ Black TSSB2624



1/2 GN Ore Dish
Size: 325 x 265 x 70mm
Capacity: 5L
■ Black TSSB2612



1/1 GN Ore Tray
Size: 325 x 265 x 35mm
Capacity: 4.5L
■ Black TSSB2511



2/4 GN Ore Tray
Size: 162 x 530 x 35mm
Capacity: 2L
■ Black TSSB2524



1/2 GN Ore Tray
Size: 325 x 265 x 35mm
Capacity: 2L
■ Black TSSB2512



1/3 GN Ore Dish
Size: 325 x 176 x 70mm
Capacity: 3L
■ Black TSSB2613



1/4 GN Ore Dish
Size: 164 x 265 x 70mm
Capacity: 2.5L
■ Black TSSB2614



Ore Small Round
Size: 260 x 195 x 65mm
Capacity: 1.1L
■ Black TSSB2615



Ore Large Round
Size: 320 x 245 x 65mm
Capacity: 1.9L
■ Black TSSB2616



Ore Large Oval
Size: 400 x 225 x 60mm
Capacity: 2L
■ Black TSSB2618



Ore Small Oval
Size: 300 x 175 x 50mm
Capacity: 1L
■ Black TSSB2617

HOT COUNTER BROCHURE 

RETAIL BROCHURE 



Stainless Steel

Professional-grade stainless steel dishes and utensils built for heat and heavy use. Clean, practical and easy to maintain. A reliable foundation for hot counter environments.



HOT COUNTER



DISHWASHER SAFE



STAINLESS STEEL



Stainless Steel Square Balti Dish
Size: 255 x 255 x 65mm
Capacity: 3L
■ Stainless Steel TSSSQ1010



Stainless Steel Forked Tongs
Size: 230mm
■ Stainless Steel TSS171



Stainless Steel Slotted Tongs
Size: 230mm
■ Stainless Steel TSS172



Stainless Steel Solid Spoon
Size: 300mm
■ Stainless Steel TSS300



Silicone Utensils

Resistant to temperatures from -40°C to 230°C, these utensils handle both chilled and hot service with ease. A practical addition to all food service environments.



HOT COUNTER



DISHWASHER SAFE



DESIGNED IN UK



Silicone Tongs
Size: 287 x 68 x 18mm
■ Black TB1061



Silicone Tweezers
Size: 291 x 68 x 16mm
■ Black TB1060



Stainless Steel & Black Silicone Tong
Size: 305mm
■ Black TSS312B



Silicone Ladle
Size: 280 x 91 x 70mm
■ Black TB1062



Silicone Spoon
Size: 305 x 65 x 55mm
■ Black TB1065



Silicone Slotted Spoon
Size: 305 x 65 x 55mm
■ Black TB1066



Silicone Spatula
Size: 224 x 40 x 16mm
■ Black TB1063



Silicone Spatula
Size: 285 x 55 x 16mm
■ Black TB1064

HOT COUNTER BROCHURE



RETAIL BROCHURE





Dalebrook®

Catering



149 Pots



151 Glazz Minatures



153 Glazz Bowls



155 Glazz Trays



157 Glazz Plates



159 Slate-look



189 Eden



Pots

Dalebrook's pots are a small change that makes a big impact. Designed for education and catering environments, they turn desserts, yoghurts, and fruit pots into something brighter, safer, and more sustainable.



DURABLE



REUSABLE



FREEZER SAFE



SAN Pudding Pot
 Size: 70 x 70 x 80mm
 Capacity: 150ml
 Sold in packs of 100
 ■ Clear TCSN4411



DURABLE



REUSABLE



FREEZER SAFE



Co-polyester Square Style Pot
 Size: 70 x 70 x 67mm
 Capacity: 200ml
 Sold in packs of 200
 ■ Clear SQ6020CP



PS Clear Square-Style Pot
 Size: 70 x 70 x 67mm
 Capacity: 200ml
 Sold in packs of 200
 ■ Clear SQ6020A



PS Clear Square-Style Pot
 Size: 65 x 65 x 65mm
 Capacity: 150ml
 Sold in packs of 200
 ■ Clear SQ6015A



PS Clear Square-Style Pot
 Size: 54 x 54 x 54mm
 Capacity: 80ml
 Sold in packs of 400
 ■ Clear SQ6008



PET Flat Lid for Square-Style Pot
 Size: 72 x 72 x 7mm
 To fit: SQ6020A
 Sold in packs of 200
 ■ Clear SQ6020L





Glazz Miniatures

Crystal clear with an icy textured surface, Glazz Pots bring refined detail to elevated finger food. Ideal for mini desserts, light bites and canapé service. Secure lids support transport, stacking and prep in fast paced catering environments.



DURABLE



REUSABLE



FREEZER SAFE



PS Glazz Sloping Pot
Size: 45 x 45 x 85mm
Capacity: 75ml
Sold in packs of 200
■ Glazz GL30330



PS Glazz Shot Glass
Size: 45 x 45 x 82mm
Capacity: 80ml
Sold in packs of 200
■ Glazz GLSHOT



PS Glazz 15cl Cube
Size: 58 x 58 x 58mm
Capacity: 150ml
Sold in packs of 100
■ Glazz GLCUBE18

POTS WITH LIDS



PS Glazz Mini Saladier
Size: 70 dia. x 25mm
Capacity: 50ml
Sold in packs of 200
■ Glazz GL30375



PET Dome Lid
Size: 80 x 73 x 32mm
To fit: GL30375
Sold in packs of 200
■ Clear R30375L



PS Glazz 5cl Cube
Size: 45 x 45 x 45mm
Capacity: 50ml
Sold in packs of 200
■ Glazz GLCUBE8



PET Flat Lid
Size: 46 x 46 x 5mm
To fit: GL30375
Sold in packs of 200
■ Clear GLCUBE8L





GL6160



GLR2000

Glazz Bowls

Glazz Bowls create a glass-like finish across buffet displays without the fragility. Lids support freshness and allow safe stacking during storage and transport.



DURABLE



REUSABLE



FREEZER SAFE

SQUARE



PS Large Glazz Cubic Bowl
Size: 183 x 183 x 95mm
Capacity: 1.6L
Sold in packs of 120
■ Glazz GL6160



PS Mini Glazz Cubic Bowl
Size: 90 x 90 x 56mm
Capacity: 200ml
Sold in packs of 200
■ Glazz GL6020

ROUND



PS Large Glazz Round Bowl
Size: 200 x 200 x 95mm
Capacity: 2L
Sold in packs of 60
■ Glazz GLR2000



PS Large Glazz Round Bowl Lid
Size: 206 x 206 x 5mm
To fit: GLR2000
Sold in packs of 60
■ Clear GLR2000L





GL3827

Glazz Trays

Cater without fear when your trays are Glazz not glass. Offering the clarity of glass in a durable, reusable format, they are ideal for canapé service and high-end events. When paired with lids, they stack neatly in refrigeration and travel confidently to site.



DURABLE



REUSABLE



FREEZER SAFE

GASTRONORM



1/1 GN PS Glazz Platter
Size: 530 x 325 x 15mm
Sold in packs of 25
■ Glazz GL1/1B



2/4 GN PS Glazz Platter
Size: 530 x 165 x 15mm
Sold in packs of 25
■ Glazz GL11/2B



1/2 GN PS Glazz Platter
Size: 325 x 265 x 15mm
Sold in packs of 25
■ Glazz GL1/2B



1/1 GN PET Lid
Size: 540 x 340 x 63mm
Sold in packs of 25
■ Clear GN1/1L



2/4 GN PET Lid
Size: 545 x 175 x 63mm
Sold in packs of 25
■ Clear GN11/2L



1/2 GN PET Lid
Size: 335 x 276 x 63mm
Sold in packs of 25
■ Clear GN1/2L

BUFFET



PS Glazz Buffet Platter
Size: 380 x 274 x 15mm
Sold in packs of 25
■ Glazz GL3827

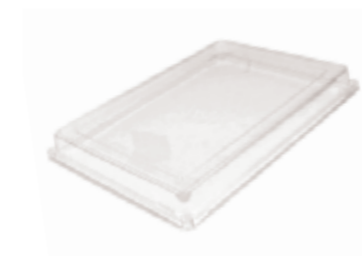

PET Buffet Lid
Size: 392 x 275 x 47mm
Sold in packs of 25
■ Clear GL3827L

ATLAS

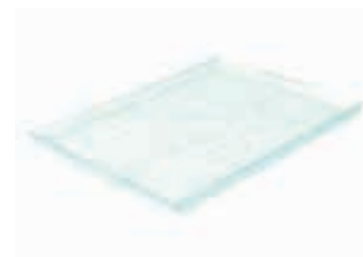

1/1 Atlas PS Glazz Platter
Size: 379 x 272 x 19.5mm
Sold in packs of 50
■ Glazz GLATLAS

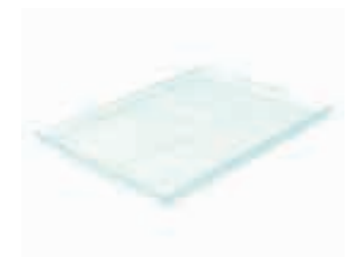

1/2 Atlas PS Glazz Platter
Size: 270 x 190 x 19mm
Sold in packs of 50
■ Glazz GL12ATLAS



1/1 Atlas PET Lid
Size: 390 x 272 x 57mm
Sold in packs of 50
■ Clear GLATLASL



1/2 Atlas PET Lid
Size: 275 x 195 x 40mm
Sold in packs of 50
■ Clear GL12ATLASL

ATLAS SIZES

Fits Atlas Footprint



GASTRONORM SIZES

Fits Gastronorm (GN)





GL23/23

Glazz Plates

Perfect for refined small portions and plated light bites, Glazz Plates deliver a crystal clear stage for food. The textured surface catches light and enhances presentation. Lids make them suitable for retail display and efficient stacking back of house.



DURABLE



REUSABLE



FREEZER SAFE

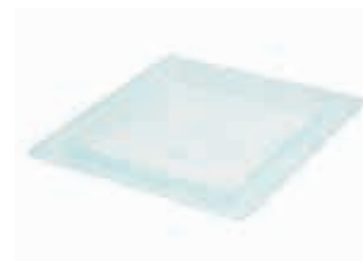

PS Glazz Square Plate
Size: 230 x 230 x 15mm
Sold in packs of 25
■ Glazz GL23/23



PET Glazz Square Lid
Size: 235 x 235 x 60mm
Sold in packs of 25
■ Clear GL23/23L

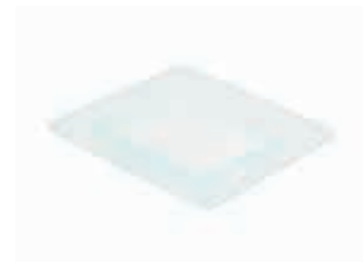

PS Glazz Square Plate
Size: 170 x 170 x 15mm
Sold in packs of 25
■ Glazz GL17/17



PET Glazz Square Lid
Size: 172 x 172 x 50mm
Sold in packs of 25
■ Clear GL17/17L



GL90





SL1/1

Slate-look

Slate-look trays offer the character of natural slate in lightweight, reusable form. Manufactured in atlas and gastronorm sizing, they suit both canapé service and retail counters. Pair with lids for stacking and transport, they combine dramatic presentation with practical performance.

GASTRONORM



1/1 GN PS Slate-Look Platter
Size: 530 x 325 x 30mm
Sold in packs of 10
■ Black SL1/1



2/4 GN PS Slate-Look Platter
Size: 530 x 165 x 30mm
Sold in packs of 10
■ Black SL11/2



1/2 GN PS Slate-Look Platter
Size: 325 x 265 x 20mm
Sold in packs of 10
■ Black SL1/2



1/1 GN PET Lid
Size: 540 x 340 x 63mm
Sold in packs of 25
Clear GN1/1L



2/4 GN PET Lid
Size: 545 x 175 x 63mm
Sold in packs of 25
Clear GN11/2L



1/2 GN PET Lid
Size: 335 x 276 x 63mm
Sold in packs of 25
Clear GN1/2L



DURABLE



REUSABLE



FREEZER SAFE

ATLAS



1/2 Atlas PS Slate-Look Platter
Size: 274 x 190 x 19mm
Sold in packs of 50
■ Black SL12ATLAS



1/2 Atlas PET Lid
Size: 275 x 195 x 40mm
Sold in packs of 50
■ Clear GL12ATLASL

ATLAS SIZES

Fits Atlas Footprint

1/1	1/2	1/1 ATLAS 379x272mm
	1/2	1/2 ATLAS 270x190mm



SL12ATLAS





Dalebrook®

Food To Go



149 Pots



151 Glazz Minatures



157 Glazz Plates



163 Hive



165 Hu



167 Kiru



171 Hoxton



173 Mayfair



Hive

Inspired by the efficiency of the hive, this modular system keeps modern catering moving with structure and control. Hive is lightweight, stackable and dishwasher ready for fast turnaround environments. Built in industry standard capacities, it supports fresh presentation, reduces reliance on disposable formats and returns to service again and again.



Hive Co-polyester Lid
Size: 227 x 187 x 18mm
Pack Size: Pack of 6
■ Clear TCC7216L

Hive Bowl
Size: 308 x 155 x 35mm
Capacity: 1L / 33oz
Pack Size: Pack of 6
■ Grey TGY72161W



Hive Co-polyester Lid
Size: 190 x 153 x 18mm
Pack Size: Pack of 12
■ Clear TCC7215L

Hive Bowl
Size: 237 x 122 x 42mm
Capacity: 700ml / 23oz
Pack Size: Pack of 12
■ Grey TGY72151W



Hive Co-polyester Lid
Size: 187 dia. x 18mm
Pack Size: Pack of 6
■ Clear TCC7218L

Hive Bowl
Size: 184 dia. x 65mm
Capacity: 1L / 23oz
Pack Size: Pack of 6
■ Grey TGY72181W



Hive Co-polyester Lid
Size: 152 dia. x 18mm
Pack Size: Pack of 6
■ Clear TCC7217L

Hive Bowl
Size: 149 dia. x 65mm
Capacity: 700ml / 23oz
Pack Size: Pack of 6
■ Grey TGY72171W



Hive Co-polyester Lid
Size: 117 dia. x 18mm
Pack Size: Pack of 12
■ Clear TCC7213L

Hive Bowl
Size: 114 dia. x 74mm
Capacity: 478ml / 16oz
Pack Size: Pack of 12
■ Grey TGY72132W



Hive Co-polyester Lid
Size: 117 dia. x 18mm
Pack Size: Pack of 12
■ Clear TCC7213L

Hive Bowl
Size: 114 dia. x 74mm
Capacity: 355ml / 12oz
Pack Size: Pack of 12
■ Grey TGY72131W

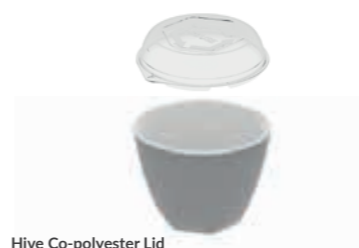

Hive Co-polyester Lid
Size: 89 dia. x 18mm
Pack Size: Pack of 12
■ Clear TCC7212L

Hive Bowl
Size: 92 dia. x 68mm
Capacity: 235ml / 8oz
Pack Size: Pack of 12
■ Grey TGY72125W



Hive Co-polyester Lid
Size: 62 dia. x 10mm
Pack Size: Pack of 24
■ Clear TCC7211L

Hive Dip Pot
Size: 59 dia. x 31mm
Capacity: 60ml / 2oz
Pack Size: Pack of 24
■ Clear TCC72112



Hive Co-polyester Lid
Size: 62 dia. x 10mm
Pack Size: Pack of 24
■ Clear TCC7211L

Hive Dip Pot
Size: 59 dia. x 19mm
Capacity: 30ml / 1oz
Pack Size: Pack of 24
■ Clear TCC72111





REUSABLE



LIDS



DURABLE

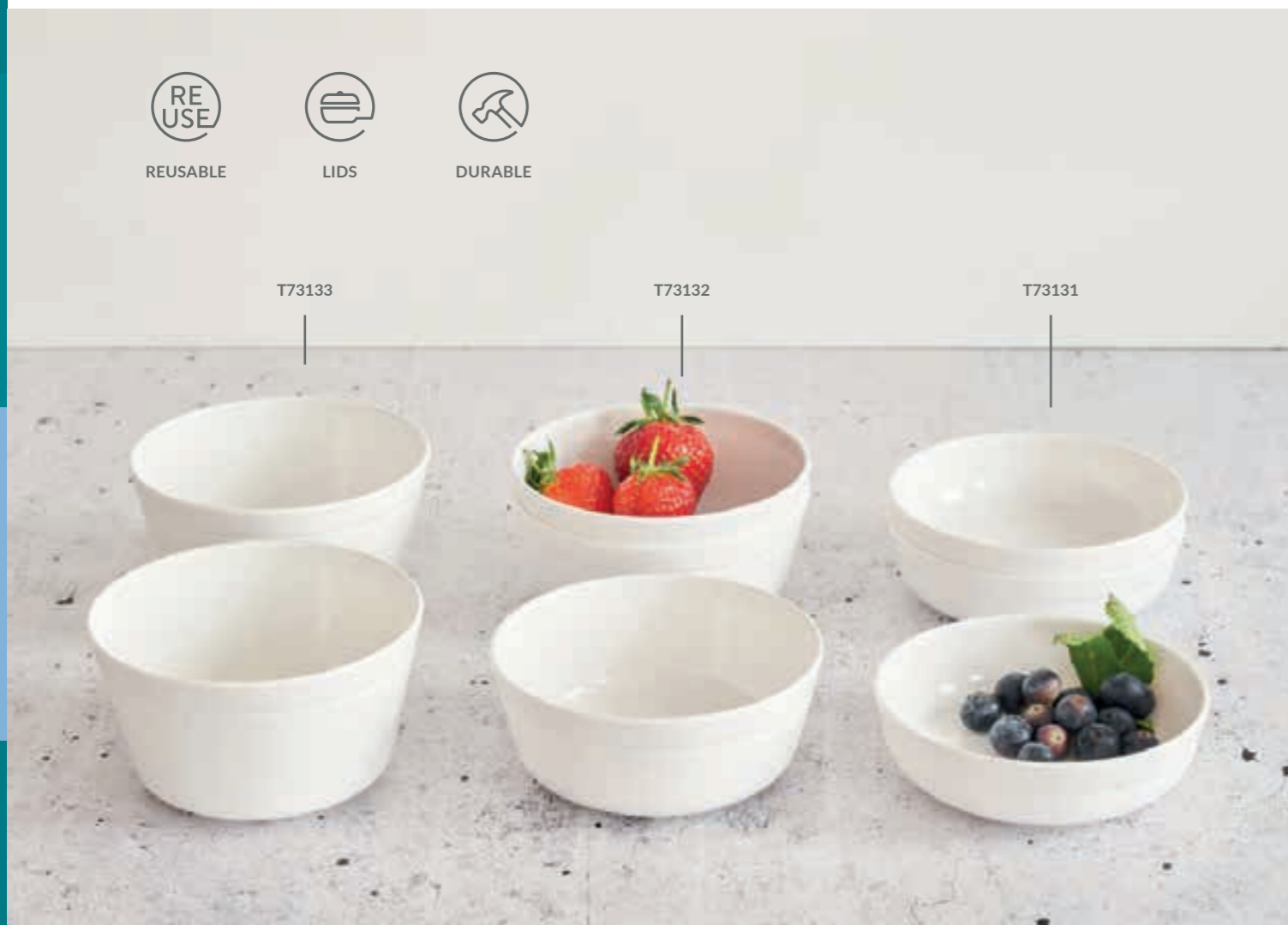

DIP POTS

Hu SAN Dip Pot Lid
Size: 77 dia. x 19mm
Pack Size: Pack of 24
■ Clear TC7311L



Hu SAN Dip Pot
Size: 74 dia. x 19mm
Capacity: 30ml / 1oz
Pack Size: Pack of 24
■ Clear TC73111



Hu SAN Dip Pot Lid
Size: 77 dia. x 19mm
Pack Size: Pack of 24
■ Clear TC7311L



Hu SAN Dip Pot
Size: 74 dia. x 27mm
Capacity: 60ml / 2oz
Pack Size: Pack of 24
■ Clear TC73112

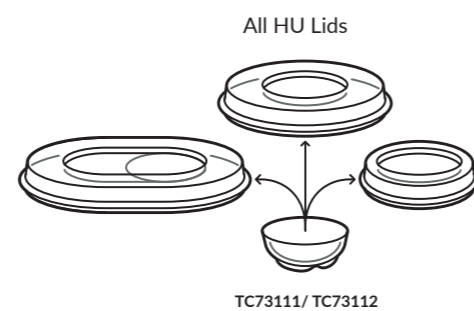

Hu

Human by design, Hu feels like real tableware rather than throwaway packaging, solid in the hand and reassuring in use. Developed with contract caterers in response to growing pressure to reduce single use packaging, it offers a durable alternative built for long term service.



Hu SAN Lid
Size: 227 x 187 x 18mm
Pack Size: Pack of 6
■ Clear TC7316L

Hu Bowl
Size: 225x185x45mm
Capacity: 1L / 33oz
Pack Size: Pack of 6
■ White T73161



Hu SAN Lid
Size: 190 x 153 x 18mm
Pack Size: Pack of 12
■ Clear TC7315L

Hu Bowl
Size: 190x149x45mm
Capacity: 700ml / 23oz
Pack Size: Pack of 12
■ White T73151



Hu SAN Lid
Size: 187 dia. x 18mm
Pack Size: Pack of 6
■ Clear TC7318L

Hu Bowl
Size: 185 dia. x 60mm
Capacity: 700ml / 23oz
Pack Size: Pack of 6
■ White T73181



Hu SAN Lid
Size: 158 dia. x 18mm
Pack Size: Pack of 6
■ Clear TC7317L

Hu Bowl
Size: 150 dia. x 60mm
Capacity: 700ml / 23oz
Pack Size: Pack of 6
■ White T73171



Hu SAN Lid
Size: 123 dia. x 18mm
Pack Size: Pack of 12
■ Clear TC7313L

Hu Bowl
Size: 122 dia. x 67mm
Capacity: 478ml / 16oz
Pack Size: Pack of 12
■ White T73133



Hu SAN Lid
Size: 123 dia. x 18mm
Pack Size: Pack of 12
■ Clear TC7313L

Hu Bowl
Size: 122 dia. x 50mm
Capacity: 355ml / 12oz
Pack Size: Pack of 12
■ White T73132



Hu SAN Lid
Size: 158 dia. x 18mm
Pack Size: Pack of 12
■ Clear TC7313L

Hu Bowl
Size: 150 dia. x 60mm
Capacity: 235ml / 8oz
Pack Size: Pack of 12
■ White T73131



Hu SAN Dessert Pot
Size: 99 dia. x 19mm
Pack Size: Pack of 12
■ Clear TC7312L

Hu SAN Dessert Pot
Size: 94 dia. x 60mm
Capacity: 285ml / 10oz
Pack Size: Pack of 12
■ Clear TC73122



TCM4105TAQ



OPEN OR CLOSED VENT



STACKABLE DESIGN



SPACE FOR CUTLERY



INSERTS



POOLSIDE

Kiru

A modern interpretation of the Bento tradition. Clean lines and divided compartments present diverse dishes with clarity and order. Strong melamine construction supports both indoor and outdoor hospitality settings.

KIRU



Kiru Bento Box with Inserts
Size: 253 x 253 x 95mm
■ Black TB4105



Kiru Bento Box with Inserts
Size: 253 x 253 x 95mm
■ White T4105



Kiru Bento Box with Inserts
Size: 253 x 253 x 95mm
■ Cream/Aqua TCM4105TAQ



FOOD-TO-GO



STACKABLE



REUSABLE

SQUARE BENTO



Black & White Bento Box with Inserts
Size: 125 x 120 x 40mm
■ Black & White T4100

INSERTS

Fits Kiru and Square Bento Box



Bento Box Insert
Size: 240 x 120 x 40mm
■ White T4103



Bento Box Insert
Size: 125 x 120 x 40mm
■ White T4104

REUSABLE BROCHURE

















POOLSIDE BROCHURE





Dalebrook®

Tableware

	11	Aura Drinkware
	45	Talon Tableware & Drinkware
	125-127	Casablanca
	57	Trafalgar
	81	Marl
	91	Enamelware
	133	Ripple
	171	Hoxton
	173	Mayfair
	175	Mineral
	177	So.Ho.
	179	Skillet & Orbit
	183	Basic & Pizza
	185	Dessert
	187	Reef
	189	Eden
	190-193	Childrens
	195	Omni

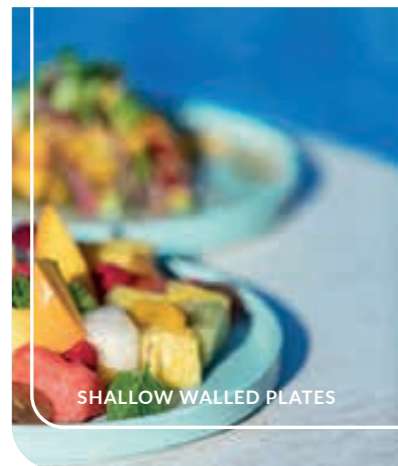

Hoxton

Hoxton combines smooth matte surfaces with architectural straight walls to create a strikingly modern collection. Each plate is made to sit securely on its matching bowl, forming a lid that allows dishes to be stacked, carried and presented with ease.



MATT FINISH



STACKABLE



REUSABLE



Hoxton Plate
Size: 228 x 228 x 21 mm
■ Black TB4643



Hoxton Plate/Lid
Size: 152 x 152 x 21 mm
■ Black TB4642



Hoxton Pot
Size: 152 x 152 x 70 mm
Capacity: 600ml
■ Black TB4641



Hoxton Plate
Size: 228 x 228 x 21 mm
■ Parchment TCM4643



Hoxton Plate/Lid
Size: 152 x 152 x 21 mm
■ Parchment TCM4642



Hoxton Pot
Size: 152 x 152 x 70 mm
Capacity: 600ml
■ Parchment TCM4641



Hoxton Plate
Size: 228 x 228 x 21 mm
■ Aqua TAQ4643



Hoxton Plate/Lid
Size: 152 x 152 x 21 mm
■ Aqua TAQ4642



Hoxton Pot
Size: 152 x 152 x 70 mm
Capacity: 600ml
■ Aqua TAQ4641

REUSABLE BROCHURE



TABLEWARE BROCHURE



POOLSIDE BROCHURE





AVAILABLE IN THREE FRESH COLOUR FINISHES



Yellow



Blue



Sage Green

Mayfair

Minimalist bento-style collection available in coordinated sizes and colours. Plates double as lids to assist with secure transport for room service and poolside dining. A refined approach for versatile hospitality environments.



FOOD-TO-GO



STACKABLE



REUSABLE



Mayfair Large Plate
278 dia. x 22 mm

- Yellow TSG4653Y
- Blue TSG4653BL
- Sage Green TSG4653G



Mayfair Large Dish 2.4 L
272 dia. x 65 mm

- Yellow TSG4655Y
- Blue TSG4655BL
- Sage Green TSG4655G



Mayfair Medium Plate
209 dia. x 23 mm

- Yellow TSG4652Y
- Blue TSG4652BL
- Sage Green TSG4652G



Mayfair Medium Dish 1.4 L
201 dia. x 63 mm

- Yellow TSG4656Y
- Blue TSG4656BL
- Sage Green TSG4656G



Mayfair Small Plate
139 dia. x 23 mm

- Yellow TSG4651Y
- Blue TSG4651BL
- Sage Green TSG4651G



Mayfair Small Dish 500 ml
131 dia. x 63 mm

- Yellow TSG4654Y
- Blue TSG4654BL
- Sage Green TSG4654G

REUSABLE
BROCHURE



TABLEWARE
BROCHURE



POOLSIDE
BROCHURE





SWATCH



Mineral

Mineral captures the depth and irregular beauty of handmade stoneware in durable melamine. A matt surface scattered with subtle glossy particles reflects light and adds dimension to plated food.



TEXTURED



ORGANIC SHAPES



LARGE RANGE



Mineral Crackle Glaze Oval Plate
Size: 229 x 305 x 30mm

- Noir TB4716
- Blanch T4716
- Parchment TCM4716
- Aqua TAQ4716
- Agate Grey TGY4716



Mineral Crackle Glaze Plate
Size: 300 x 300 x 52mm

- Noir TB4710
- Blanch T4710
- Parchment TCM4710
- Aqua TAQ4710
- Agate Grey TGY4710



Mineral Crackle Glaze Plate
Size: 254 x 254 x 30mm

- Noir TB4713
- Blanch T4713
- Parchment TCM4713
- Aqua TAQ4713
- Agate Grey TGY4713



Mineral Crackle Glaze Bowl
Size: 240 x 240 x 50mm
Capacity: 1.3L

- Noir TB4708
- Blanch T4708
- Parchment TCM4708
- Aqua TAQ4708
- Agate Grey TGY4708
- Himalayan TPK4708



Mineral Crackle Glaze Plate
Size: 205 x 205 x 43mm

- Noir TB4709
- Blanch T4709
- Parchment TCM4709
- Aqua TAQ4709
- Agate Grey TGY4709



Mineral Crackle Glaze Plate
Size: 203 x 203 x 30mm

- Noir TB4712
- Blanch T4712
- Parchment TCM4712
- Aqua TAQ4712
- Agate Grey TGY4712



Mineral Crackle Glaze Bowl
Size: 160 x 160 x 43mm
Capacity: 450ml

- Noir TB4715
- Blanch T4715
- Parchment TCM4715
- Aqua TAQ4715
- Agate Grey TGY4715



Mineral Crackle Glaze Ramekin
Size: 86 x 86 x 30mm
Capacity: 65ml

- Noir TB4714
- Blanch T4714
- Parchment TCM4714
- Aqua TAQ4714
- Agate Grey TGY4714

TABLEWARE BROCHURE



POOLSIDE BROCHURE





TB4634

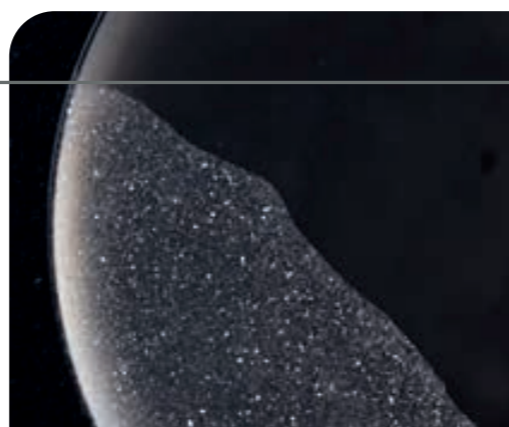

So.Ho

Specialist moulding creates unique surface variations across each piece. Muted tones and textured finishes add depth without distraction. A contemporary choice that brings individuality to the table.



So.Ho Melamine Low Bowl
 Size: 280 x 280x 52mm
 Capacity: 2.1L
 ■ Black & Speckled Black TB4635



So.Ho Melamine Plate
 Size: 285 x 285x 52mm
 ■ Black & Speckled Black TB4632



So.Ho Melamine Plate
 Size: 280 x 280x 52mm
 ■ Black & Speckled Black TB4631



So.Ho Melamine Bowl
 Size: 216 x 216x 92mm
 Capacity: 1.9L
 ■ Black & Speckled Black TB4634



So.Ho Melamine Bowl
 Size: 152 x 152x 72mm
 Capacity: 750ml
 ■ Black & Speckled Black TB4633



DISHWASHER SAFE



SPECKLED



DESIGNED IN UK





Skillet

Melamine skillets that capture the look of cast iron without the weight. Two sizes offer flexibility for sharing concepts.



Skillet Large Plate
 Size: 330 x 276 x 35mm
 Capacity: 550ml
 ■ Black TB3533



Skillet Small Plate
 Size: 262 x 216 x 35mm
 Capacity: 350ml
 ■ Black TB3526

EXAMPLE OF OUR SKILLET PLATE USED IN A RETAIL COUNTER DISPLAY



DISHWASHER SAFE



TEXTURE



DESIGNED IN UK





TPO2102

Orbit

Smooth forms and balanced proportions provide a modern plating canvas. Lightweight yet strong, Orbit is a clean stage for bold culinary presentation.



DISHWASHER
SAFE



PREMIUM
QUALITY



DESIGNED IN UK



Orbit Large Plate
Size: 250 dia. x 23mm
■ White T4850



Orbit Small Plate
Size: 230 dia. x 23mm
■ White T4830



Orbit Bowl
Size: 160 x 160 x 50mm
Capacity: 500ml
■ White T4860



Orbit Mug
Size: 80 x 80 x 85mm
Capacity: 225ml
■ White T4818



Orbit Cup
Size: 115 x 92 x 65mm
Capacity: 175ml
■ White T4815



Orbit Espresso Cup
Size: 66 x 66 x 68mm
Capacity: 120ml
■ White T4816



Orbit Saucer
Size: 140 x 140 x 15mm
Capacity: 225ml
Use with: T4815 & T4816
■ White T4814





Basic

Crisp lines and dependable construction make Basic a reliable everyday collection. Built to withstand professional service while remaining visually neutral. Available for customisation to align with brand identity. If you would like a customised version of the Basic Collection, please contact us about MOQs.



DISHWASHER SAFE



STACKABLE



DESIGNED IN UK



Basic Large Plate
Size: 250 x 250 x 20mm
White TPO3210



Basic Small Plate
Size: 225 x 225 x 20mm
white TPO3209



Basic Cereal Bowl
Size: 150 x 150 x 45mm
Capacity: 400ml
White TPO2102



Pizza

Plates sized to suit classic formats with a subtle ripple texture that mimics real porcelain. Dalebrook's melamine pizza plates elevate casual dining through considered detail.



CHIP RESISTANT



STACKABLE



DESIGNED IN UK



White Melamine Pizza Plate
Size: 350mm (13 3/4")
white T3014



Bianca Pizza Plate
Size: 350mm (13 3/4")
bianca T2014



Bianca Pizza Plate
Size: 310mm (12 1/4")
bianca T2225





Dessert

Bright tones introduce energy to service. Durable construction supports high turnover settings. A playful yet practical finish to the dining experience.



DISHWASHER SAFE



STACKABLE



DESIGNED IN UK



Melamine Dessert Plate
Size: 140 x 140 x 22mm
■ Blue TBL14022W



Melamine Dessert Plate
Size: 140 x 140 x 22mm
■ Green TGR14022W



Melamine Dessert Plate
Size: 140 x 140 x 22mm
■ Orange TOR14022W



Melamine Dessert Plate
Size: 140 x 140 x 22mm
■ Pink TPK14022W



Melamine Dessert Plate
Size: 140 x 140 x 22mm
■ Red TR14022W



Melamine Dessert Plate
Size: 140 x 140 x 22mm
■ Yellow TYE14022W



Polycarbonate Dessert Plate Lid
Size: 130 x 130 x 58mm
■ Clear TC180L





T1541M

TPK1542M



Reef

Compact ramekins ideal for sauces and small bites. Refined shapes allows grouping for buffet or canapé service. A subtle way to structure small portions with clarity.



MINIATURES



SPACE SAVING



DESIGNED IN UK



Matt Reef Bowl
Size: 94 x 90 x 64mm
Capacity: 120ml
 White T1541M
 Aqua TAQ1541M
 Parchment TCM1541M
 Pink TPK1541M
 Stone TST1541M
 Grey TGY1541M
 Terracotta TT1541M
 Black TB1541M



Matt Reef Oval Bowl
Size: 82 x 66 x 43mm
Capacity: 60ml
 White T1543M
 Aqua TAQ1543M
 Parchment TCM1543M
 Pink TPK1543M
 Stone TST1543M
 Grey TGY1543M
 Terracotta TT1543M
 Black TB1543M



Matt Reef Low Bowl
Size: 137 x 82 x 33mm
Capacity: 60ml
 White T1542M
 Aqua TAQ1542M
 Parchment TCM1542M
 Pink TPK1542M
 Grey TGY1542M
 Terracotta TT1542M
 Black TB1542M



Gloss Reef Bowl
Size: 94 x 90 x 64mm
Capacity: 120ml
 White T1541
 Black TB1541



Gloss Reef Oval Bowl
Size: 82 x 66 x 43mm
Capacity: 60ml
 White T1543
 Black TB1543



Gloss Reef Low Bowl
Size: 137 x 82 x 33mm
Capacity: 60ml
 White T1542
 Black TB1542



Gloss Reef Square Bowl
Size: 100 x 100 x 37mm
Capacity: 60ml
 White T1544

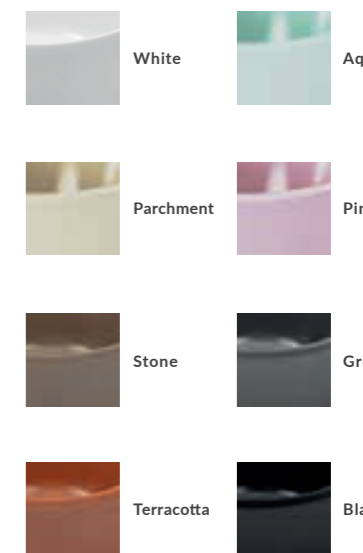



Eden

Miniature forms that support precision plating. Lightweight and durable for repeated use. Eden adds detail without overpowering the presentation.



MINIATURES



SPACE SAVING



DESIGNED IN UK



Mini Calla Bowl
Size: 101 x 100 x 49mm
Capacity: 45ml
■ White T1081



Mini Tulipa Bowl
Size: 86 x 77 x 50mm
Capacity: 50ml
■ White T1083



Mini Lotus Bowl
Size: 86 x 77 x 55mm
Capacity: 65ml
■ White T1091



Hors d'oeuvre Melamine Spoon
Size: 140mm
■ White T6020
■ Black TB6020



Appetite Concave Dish
Size: 105 x 105 x 15mm
■ White T1640

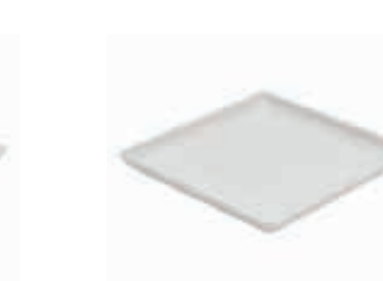

Appetite Flat Dish
Size: 105 x 105 x 15mm
■ White T1641

RAMEKINS *Sold in packs of 12*



Ramekin Bowl
Size: 60 dia. x 40mm
Pack: Sold in packs of 12
Capacity: 45ml
■ White T11515



Stackable Ribbed Ramekin
Size: 85 dia. x 38mm
Pack: Sold in packs of 12
Capacity: 120ml
■ White T14040R





KT5207

KT5202

Little Monsters

Transform mealtime into a playful adventure with Dalebrook's charming Little Monsters Junior Tableware. Practical and robust, this collection is designed to withstand the unruliest of diners.



DISHWASHER SAFE



DURABLE



DESIGNED IN UK



Bert The Monster Melamine Plate
Size: 245 x 240 x 22mm
■ Bert KT5203



Nettle The Monster Melamine Plate
Size: 245 x 240 x 22mm
■ Nettle KT5213



Hector The Monster Melamine Plate
Size: 245 x 240 x 22mm
■ Hector KT5223



Bert The Monster Melamine Bowl
Size: 127 x 124 x 43mm
Capacity: 150ml
■ Bert KT5202



Nettle The Monster Melamine Bowl
Size: 127 x 124 x 43mm
Capacity: 150ml
■ Nettle KT5212



Hector The Monster Melamine Bowl
Size: 127 x 124 x 43mm
Capacity: 150ml
■ Hector KT5222



Bert The Monster Melamine Cup
Size: 115 x 75 x 70mm
Capacity: 200ml
■ Bert KT5207



Nettle The Monster Melamine Cup
Size: 115 x 75 x 70mm
Capacity: 200ml
■ Nettle KT5217



Hector The Monster Melamine Cup
Size: 115 x 75 x 70mm
Capacity: 200ml
■ Hector KT5227



Monster Knife & Fork Cutlery Set
Size: 142mm
■ Monster KT5210





DISHWASHER SAFE



DURABLE



DESIGNED IN UK

Animals

Dalebrooks Animal Junior Tableware adds warmth and whimsy to children's food service, while durable melamine construction ensures long term reliability. A thoughtful addition to family friendly settings.



Flamingo Melamine Bowl
Size: 283 x 222 x 22mm
■ Flamingo KT7066FO



Flamingo Melamine Bowl
Size: 145 x 113 x 35mm
Capacity: 150ml
■ Flamingo KT7063FO



Flamingo Melamine Cup
Size: 75 x 75 x 107mm
Capacity: 300ml
■ Flamingo KT2234FO



Flamingo Melamine Spoon
Size: 142mm
■ Flamingo KT7061FO



Lion Melamine Bowl
Size: 283 x 222 x 22mm
■ Lion KT7066LN



Lion Melamine Bowl
Size: 145 x 113 x 35mm
Capacity: 150ml
■ Lion KT7063LN



Lion Melamine Cup
Size: 75 x 75 x 107mm
Capacity: 300ml
■ Lion KT2234LN



Lion Melamine Spoon
Size: 142mm
■ Lion KT7061LN



Monkey Melamine Bowl
Size: 283 x 222 x 22mm
■ Monkey KT7066MY



Monkey Melamine Bowl
Size: 145 x 113 x 35mm
Capacity: 150ml
■ Monkey KT7063MY



Monkey Melamine Cup
Size: 75 x 75 x 107mm
Capacity: 300ml
■ Monkey KT2234MY



Monkey Melamine Spoon
Size: 142mm
■ Monkey KT7061MY



Penguin Melamine Bowl
Size: 283 x 222 x 22mm
■ Penguin KT7066PN



Penguin Melamine Bowl
Size: 145 x 113 x 35mm
Capacity: 150ml
■ Penguin KT7063PN



Penguin Melamine Cup
Size: 75 x 75 x 107mm
Capacity: 300ml
■ Penguin KT2234PN



Penguin Melamine Spoon
Size: 142mm
■ Penguin KT7061PN

TABLEWARE BROCHURE





Omni

Developed for health and social care environments. Strong, virtually unbreakable melamine promotes independence while maintaining dignity at the table. Built to support safe and practical service.



SINGLE GRIP



PLACEMENT AID



ANTI SLIP

TABLEWARE



OMNI White Melamine Large Deep Plate
 Size: 240 x 230 x 35mm
 Capacity: 550ml
 Blue Rim T3833BL
 Red Rim T3833R



OMNI White Melamine Large Low Plate
 Size: 240 x 230 x 20mm
 Capacity: 200ml
 Blue Rim T3832BL
 Red Rim T3832R



OMNI White Melamine Bowl
 Size: 180 x 170 x 50mm
 Capacity: 400ml
 Blue Rim T3820BL
 Red Rim T3820R



OMNI White Melamine Small Deep Plate
 Size: 180 x 170 x 35mm
 Capacity: 300ml
 Blue Rim T3831BL
 Red Rim T3831R



OMNI White Melamine Small Low Plate
 Size: 180 x 170 x 20mm
 Capacity: 140ml
 Blue Rim T3830BL
 Red Rim T3830R

DRINKWARE



OMNI White Melamine Mug
 Size: 130 x 90 x 100mm
 Capacity: 300ml
 Blue Rim T3811BL
 Red Rim T3811R



OMNI White Melamine Cup
 Size: 130 x 90 x 70mm
 Capacity: 200ml
 Red Rim T3810R



OMNI White Melamine Saucer
 Size: 140 x 130 x 18mm
 Capacity: 200ml
 Blue Rim T3800BL
 Red Rim T3800R





Dalebrook®

Utensils



145 Silicone Utensils



199 Dressing Pots & Ladles



201 Spoons



203 Tongs



T5575

T5570

Dressing Pots

Compact pots that keep sauces controlled and service tidy. Made from durable materials that withstand repeated handling these are essential tools for organised food presentation.



DISHWASHER
SAFE



DURABLE



PREMIUM
QUALITY

ANGLED DRESSING POT



Angled Dressing Pot
Size: 130 x 130 x 160mm
Capacity: 1L
■ Cream TCM5576



Angled Dressing Pot
Size: 130 x 130 x 160mm
Capacity: 1L
■ Grey TGY5576



Angled Dressing Pot Lid
Size: 130 x 130 x 25mm
■ Tura TWD5566L

HEAVYWEIGHT DRESSING POT



Heavyweight Dressing Pot
Size: 140 x 140 x 207mm
Capacity: 2L
■ White T5570



Heavyweight Dressing Pot
Size: 110 x 110 x 167mm
Capacity: 1L
■ White T5571



Heavyweight Sauce Pot
Size: 150 x 150 x 87mm
Capacity: 1L
■ White T5575

LADLES



Solid Ladle
Size: 300mm
Capacity: 10z
■ Black TB211
■ White T211



Solid Ladle
Size: 217mm
Capacity: 0.6oz
■ Black TB210
■ White T210



Silicone Ladle
Size: 280 x 91 x 70mm
■ Black TB1062

OIL BOTTLE



Clear Copolyester Oil Bottle with Easy Pour Lid
Size: 62 x 2306mm
Capacity: 350ml
■ Clear TC4530B
Size: 75 x 295mm
Capacity: 700ml
■ Clear TC4570B

RETAIL
BROCHURE





HYGIENIC



DURABLE



VARIETY OF FOODS

Spoons

Serving spoons shaped for buffet and counter use. Balanced weight and durable build support frequent handling. Practical additions to all food service environments.



Solid Spoon
Size: 310mm
 ■ Black TB106N
 ■ White T106N
 ■ Grey TGY106N
 ■ Clear Polycarbonate TC106



Solid Spoon
Size: 250mm
 ■ Black TB104N
 ■ White T104N
 ■ Grey TGY104N



Solid Spoon
Size: 220mm
 ■ Black TB102N
 ■ White T102N



Slotted Spoon
Size: 310mm
 ■ Black TB105N
 ■ White T105N



Perforated Spoon
Size: 250mm
 ■ Black TB103N
 ■ White T103N



Small Spoon
Size: 182mm
 ■ Black TB8008
 ■ White T8008



Stainless Steel Solid Spoon
Size: 300mm
 ■ Stainless Steel TSS300



Black Utensil Rest
Size: 194 x 65 x 55mm
 ■ Black TB101



NEW
Silicone Spoon
Size: 305 x 65 x 55mm
 ■ Black TB1065



NEW
Silicone Slotted Spoon
Size: 305 x 65 x 55mm
 ■ Black TB1066





TB40510

Tongs

Reliable grip and strong construction for self-service and buffet areas. Easy to handle during high turnover periods. A hygienic and practical serving tool.



Polycarbonate Tongs
Size: 240mm
■ Black TB12
■ White T12
■ Clear Polycarbonate TC12



Polycarbonate Tongs with Plastic Cord & Metal Clasp
Size: 240mm
■ Black TB12S



Polycarbonate Tongs
Size: 230mm
■ Black TB40510
■ White T40510



Stainless Steel & Silicone Tongs
Size: 305mm
■ Stainless Steel & Black Silicon TSS312B



Stainless Steel Forked Tongs
Size: 230mm
■ Stainless Steel TSS171



Stainless Steel Slotted Tongs
Size: 230mm
■ Stainless Steel TSS172



Silicone Tongs
Size: 287 x 68 x 18mm
■ Black TB1061



Silicone Tweezers
Size: 291 x 68 x 16mm
■ Black TB1060



HYGIENIC



DURABLE



VARIETY OF FOODS

USAGE

Fresh Food Counters

- Butchery / Meat Counter
- Fish & Seafood Counter
- Deli / Charcuterie Counter

Bakery & Café

- Patisserie Counter
- Cake Display
- Sandwich Counter

Hospitality & Foodservice

- Hotel Breakfast Buffet
- Catering Buffet
- Restaurant Display Counter

BUFFET BROCHURE



RETAIL BROCHURE





Dalebrook®

Display Props



207 Dividers



209 Garnish Dividers



210 Garnish



211 Jigsaw Garnish



211 Double Grass Garnish



213 Flex



215 Ticket Clamps & Pins



217 Ticket Stands



219 Ticketing

BRAND
NEW
FOR 2026



Dividers

Clear separation within retail counters to keep displays structured and organised. Simple components that improve flow for the consumer.



Red PVC Extruded Divider
Size: 750 x 110mm
■ Blue DR52



Black PVC Extruded Divider
Size: 750 x 110mm
■ Black DBK52



Acrylic Wave Divider
Size: 750 x 250mm
■ Blue DMB3



Acrylic Fish Divider
Size: 750 x 250mm
■ Blue DMB2



NEW
Poultry Animal Divider
Size: 750 x 110mm
■ Black TB7018CK



NEW
Beef Animal Divider
Size: 750 x 110mm
■ Black TB7018CW



NEW
Pork Animal Divider
Size: 750 x 110mm
■ Black TB7018PG



NEW
Lamb Animal Divider
Size: 750 x 110mm
■ Black TB7018SH





Garnish Dividers

Garnish Dividers create clean separation across fresh food and butcher counters. They provide a structured, hygienic way to define product sections.



GARNISH (DIVIDER BASE SOLD SEPARATELY)



Heavy Duty Green Garnish (Divider base sold separately)
 Size: 375mm
 Pack: sold as pack of 12 (total length 4.5m)
 ■ Green XR32T



Heavy Duty Red & Green Garnish (Divider base sold separately)
 Size: 375mm
 Pack: sold as pack of 12 (total length 4.5m)
 ■ Red/Green XRR32T

DIVIDER BASE (HEAVY DUTY GARNISH SOLD SEPARATELY)



Garnish Divider Base 60mmH (Heavy Duty Garnish sold separately)
 Size: 750 x 60mm
 Pack: sold as pack of 6 (total length 4.5m)
 ■ Black XBB34B



Garnish Divider Base 35mmH (Heavy Duty Garnish sold separately)
 Size: 750 x 35mm
 Pack: sold as pack of 6 (total length 4.5m)
 ■ Black XBB32B



Garnish

From classic cypress and spruce to brighter sunflower and coleus finishes, garnish adds colour and character to your counters. Choose a garnish to match the theme of your counter.



- +
HYGIENIC
- 🔨
DURABLE
- 👤
BUTCHERY

GARNISH (BASE SOLD SEPARATELY)



Green Cypress Garnish (base sold separately)
Size: 250mm
Pack: sold as pack of 12 (total length 3m)
■ Green XR18T

Red & Green Cypress Garnish (base sold separately)
Size: 250mm
Pack: sold as pack of 12 (total length 3m)
■ Red/Green XRR18T

Green Spruce Garnish (base sold separately)
Size: 250mm
Pack: sold as pack of 12 (total length 3m)
■ Green XR44T



Luxury Parsley Garnish (base sold separately)
Size: 250mm
Pack: sold as pack of 12 (total length 3m)
■ Green XR35T

Yellow Sunflower Garnish (base sold separately)
Size: 250mm
Pack: sold as pack of 12 (total length 3m)
■ Yellow XR49T

Red & Green Coleus Garnish (base sold separately)
Size: 250mm
Pack: sold as pack of 12 (total length 3m)
■ Red/Green XR42T

BASE (GARNISH SOLD SEPARATELY)



25cm Garnish Base (garnish sold separately)
Size: 250mm
Pack: sold as pack of 12 (total length 3m)
■ Black XBB25B
■ White XB25B

50cm Garnish Base (garnish sold separately)
Size: 500mm
Pack: sold as pack of 6 (total length 3m)
■ Black XBB50B

75cm Garnish Base (garnish sold separately)
Size: 750mm
Pack: sold as pack of 4 (total length 3m)
■ Black XBB75B
■ White XB75B

Jigsaw Garnish

- +
HYGIENIC
- 🔗
SLOT TOGETHER
- 📦
READY ASSEMBLED

Jigsaw Garnish allows counters to adapt quickly to changing layouts. A flexible way to maintain visual consistency.

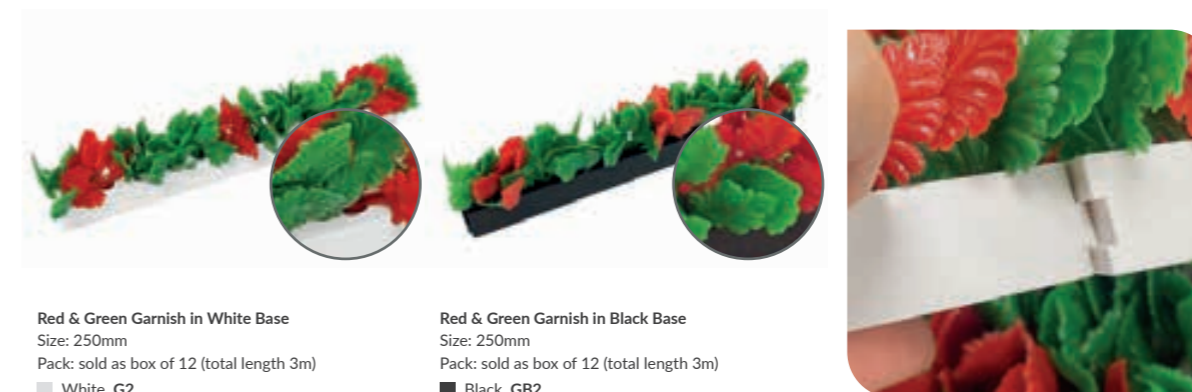

Red & Green Garnish in White Base
Size: 250mm
Pack: sold as box of 12 (total length 3m)
■ White G2

Red & Green Garnish in Black Base
Size: 250mm
Pack: sold as box of 12 (total length 3m)
■ Black GB2

Double Grass Garnish

- +
HYGIENIC
- 🔨
DURABLE
- 👤
BUTCHERY

This garnish fits into a dedicated double-channel base to create a fuller grass effect. One pack of 48 pieces fits one pack of double-channel bases.

GRASS GARNISH (BASE SOLD SEPARATELY)



Grass Garnish (Base sold separately)
Size: 125mm
Pack: sold as pack of 48 (total length 3m)
■ Green XR38T

GRASS BASE (GRASS GARNISH SOLD SEPARATELY)



25cm Grass Garnish Base (garnish sold separately)
Size: 250mm
Pack: sold as pack of 12 (total length 3m)
■ Black XBB2125B
■ White XB2125B

50cm Grass Garnish Base (garnish sold separately)
Size: 500mm
Pack: sold as pack of 6 (total length 3m)
■ Black XBB2150B



Flex

Flex grips tickets securely from multiple angles, keeping pricing and product information clearly visible across the counter. Available in three heights with stand, disc, clamp and stabber options, it adapts easily to all displays.



STAND



Nylon Flex Ticket Stand Tall
Size: 44 x 120mm
Pack Size: Sold in packs of 10
■ Black TKB999



Nylon Flex Ticket Stand Medium
Size: 44 x 80mm
Pack Size: Sold in packs of 10
■ Black TKB99



Nylon Flex Ticket Stand Small
Size: 44 x 52mm
Pack Size: Sold in packs of 10
■ Black TKB9

DISC STAND



Nylon Flex Ticket Disc Stand
Size: 46 x 7mm
Pack Size: Sold in packs of 10
■ Black TKB90

CLAMP



Nylon Flex Ticket Clamp
Size: 58 x 20 x 26mm
Pack Size: Sold in packs of 10
■ Black TKB9901

ICE STABBER



Nylon Flex Ticket Ice Stabber
Size: 210 x 20 x 20mm
Pack Size: Sold in packs of 10
■ Black TKB9902





Ticket Clamps and Pins

Durable ticket holders built for fresh food retail. Secure grip prevents movement during service. A professional finish to counter communication.



HYGIENIC



DURABLE



TICKETING

TICKET CLAMPS



PC Horizontal Ticket Clamp
Size: 20mm
Pack: Sold in packs of 10
■ Black TKB30020C



Polycarbonate Adjustable Clamp
Size: 20mm
Pack: Sold in packs of 10
■ Black TKB10020C
■ White TK10020C
■ Clear TKC10020C



Polycarbonate Shelf Clamp
Size: 50mm
Pack: Sold in packs of 10
■ Black TKB61

TICKET PINS



Nylon Square Top Pin
Size: 65mm
Pack: Sold in packs of 10
■ Black TKB661



Nylon Flat Top Pin
Size: 65mm
Pack: Sold in packs of 10
■ Black TKB66





TK35

Ticket Stands

Freestanding ticket holders for bakery and buffet environments. Dalebrooks selection of tickets stands are a finishing touch not to be forgotten for clear information presentation without clutter.



HYGIENIC



DURABLE



TICKETING



Nylon Ticket Holder
Size: 20 x 20 x 16mm
Pack: Sold in packs of 10
■ Black TKB100



Spoon & Fork Ticket Clamp
Size: 58mm
Pack: Sold individually
■ Zinc Alloy TK30

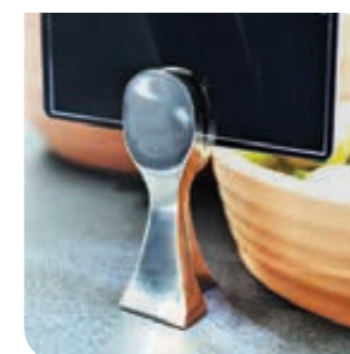

Harp Ticket Stand
Size: 40mm
Pack: Sold in packs of 10
■ Zinc Alloy TK35
■ Copper TCOP35

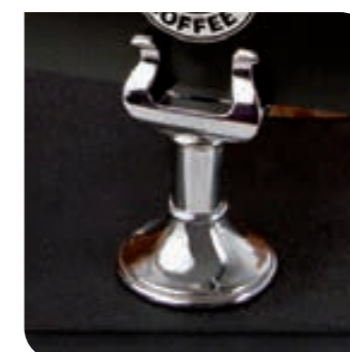



TKBM1400

Ticketing

Personalised information that supports clear product communication. Built for busy service environments where clarity matters. Practical components that complete the display.



HYGIENIC



DURABLE



TICKETING

CHALKBOARDS & STAND



A4 Matt Finish Melamine Chalkboard
Size: 297 x 210mm
■ Black TKBM1400



A5 Matt Finish Melamine Chalkboard
Size: 210 x 148mm
■ Black TKBM1500



A6 Matt Finish Melamine Chalkboard
Size: 148 x 105mm
■ Black TKBM1600

MELAMINE TICKET STAND



Melamine Ticket Stand
Size: 100 x 100mm
■ Black TKB1000



Melamine Ticket Stand
Size: 100 x 100mm
■ White TK1000



BLANK TICKETS



Blank Ticket
Size: 86 x 54mm
Pack: Sold in packs of 10
■ White TK1025

FITS ALL OUR
TICKET CLAMPS,
PINS, AND
STANDS

PAGES 213 - 217

BUFFET
BROCHURE

RETAIL
BROCHURE



NOT FOUND EXACTLY WHAT YOU'RE LOOKING FOR?

We offer a bespoke product design service for customers who need more than what's on the page.

Whether it's a different colour, a new size, personalised branding, or an entirely new product, our team supports you from concept through to creation.

What we can customise

- Colour matching across existing products
- Size or shape adaptations
- Logo application and branding
- Material or finish changes
- Fully bespoke product design

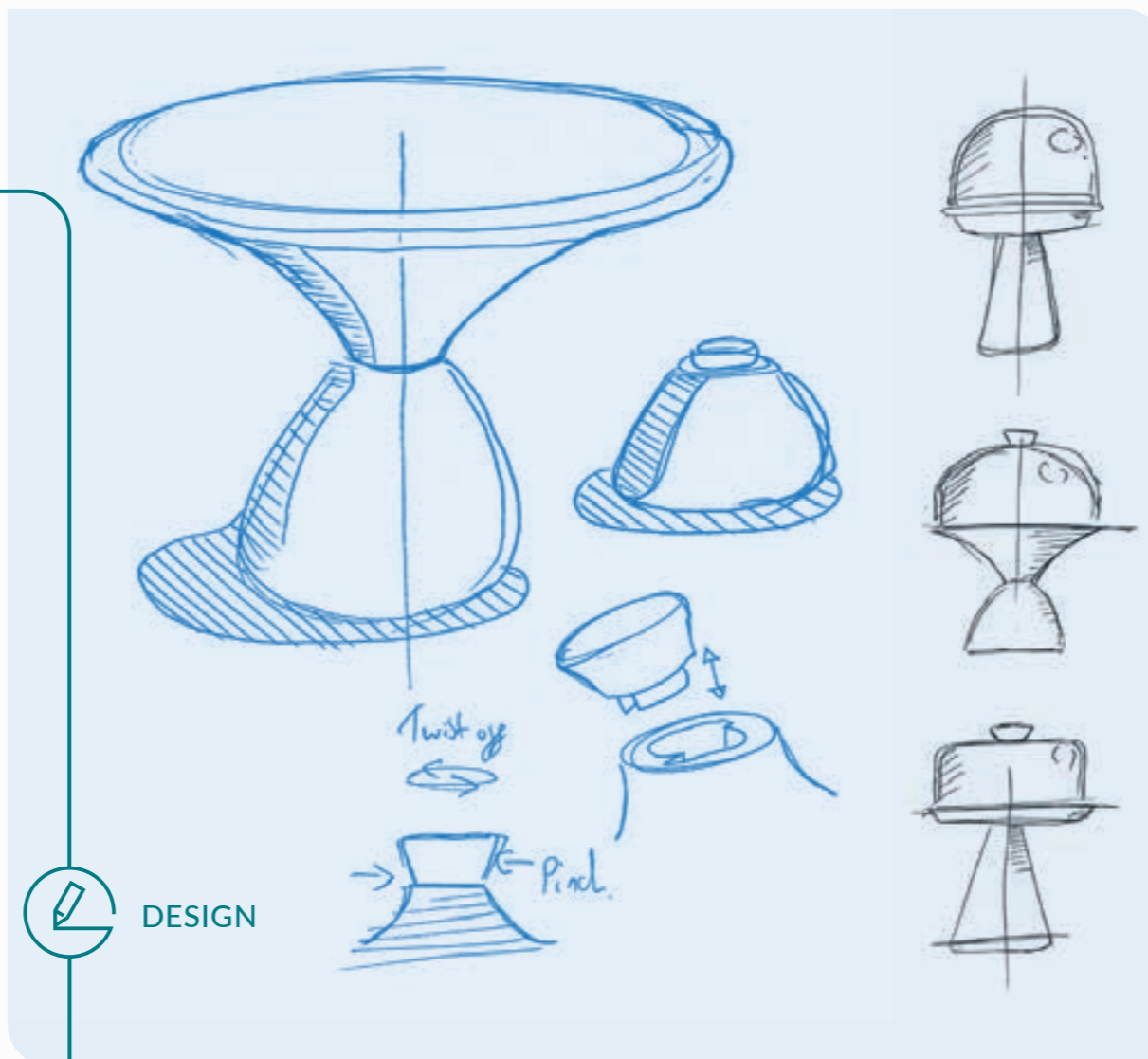

DESIGN

Minimum order quantities

Bespoke production operates on minimum order quantities, which vary by production method:

- Bespoke colour on an existing product
MOQ: 500 units
- Logo decals or applied branding
MOQ: 500 units
- Bespoke product design using existing tooling
MOQ: 500 units
- Fully bespoke product design using bespoke tooling. MOQs vary by complexity, material and tooling
Please enquire



DEVELOPMENT

For more information on our bespoke design services, please contact our sales team today:

sales@dalebrook.com
+44 (0) 1376 510 101

Loom Prototyping



SERVICE



Global reach local expertise

Dalebrook products are designed, tested, and trusted worldwide. With international distribution and rigorous quality control at every stage, we deliver design-led display solutions wherever you are.

Shipping to over
64 countries
worldwide

**Dedicated
export team**
managing
end-to-end
service

**Streamlined
international
logistics** for
faster delivery

**Strict quality
control** at every
production
stage

**Thousands
of product
lines** shipped
worldwide
each year

**Global
distribution
centres** in the
UK, Europe, and
China



Terms & Conditions

1. Definitions

“The Company” shall mean Dalebrook Supplies Ltd. or Remmerco Ltd. “The Customer” shall mean the person, firm or company to whom any quotation is addressed or with whom any verbal or written contract is made. “The Goods” shall where the context permits include units, parts and accessories agreed to be sold.

2. General

(a) Any order including any based on, or resulting from any quotation is deemed to incorporate these terms and conditions; and these terms and conditions supersede any terms or conditions proposed by the Customer and shall prevail over any inconsistent terms or conditions contained in or referred to in any order, correspondence or elsewhere and all or any arrangements to the contrary are hereby extinguished.

(b) The Company accepts no responsibility for the accuracy of drawings, patterns or specifications supplied by the Customer. No orders placed by the Customer whether resulting from a quotation or otherwise shall constitute a legally enforceable contract until accepted by the Company. The placing of an order based on a quotation supplied by the Company or in the absence of prior quotation the acceptance of an order imports therein the terms and conditions set out here under.

(c) Any information or technical assistance given by the Company is given in good faith and is for general guidance only, and does not constitute a warranty, guarantee or recommendation of the suitability of the goods for any specific purpose.

3. Quotations

(a) All tenders, quotations and estimates made by the Company are given without obligation and are subject to written confirmation when the order is placed.

(b) Although every effort will be made to meet delivery dates these are not guaranteed, the Company cannot be held responsible for loss or damage due to delay in delivery, nor shall the Customer be entitled to refuse to accept goods because of late delivery.

(c) The time given for the execution of the order shall be reckoned from the date of receipt of the Customer’s written order or from the date on which all information and drawings necessary to enable the Company to proceed is received, whichever date may be the later.

4. Corrections

The Company reserves the right to correct any clerical or typographical errors made by its employees, servants or agents at any time.

5. Prices

(a) Whilst every effort will be made to maintain prices as quoted, the Company will only accept orders at prices ruling on the day of despatch, and such price shall be fixed at the Company’s discretion after taking into account any increase in the cost of materials, transport and any other relevant factors; and the Customer hereby agrees to pay the price as invoiced. The Customer also agrees to pay for any loss or extra cost incurred by the Company through any request or instruction or lack of instructions or if there is any suspension of work due to the instructions or lack of instructions on the part of the Customer, its employees or contractors. Unless otherwise indicated in the Company’s quotation no discount of any kind is allowable. Prices being strictly nett.

(b) VAT will be charged at the rate applicable at the time of despatch.

(c) All prices and specifications are subject to alteration without notice.

(d) If an invoice is not agreed then it is incumbent upon the Customer to communicate this fact to the Company immediately as under no circumstances will any dispute be acknowledged by the Company more than 7 days after the date of the invoice.

6. Orders & Schedules

All verbal orders or instructions should be confirmed in writing within 3 days. Orders accepted by the Company cannot be cancelled without the consent of the Company in writing.

7. New Accounts

Two approved trade references and a bank reference are requested.

8. Carriage

Carriage is effected at the Company’s option and appropriate charges will be made for such carriage based on current Carriage Standard Rates. Unloading is Customer’s liability.

9. Payment

Unless otherwise agreed in writing, prices quoted and agreed by the Company and the Customer are nett prices. These are payable in accordance with the credit terms agreed between “The Company” and “The Customer”, as stated in the credit facilities agreement letter issued by “The Company” to “The Customer”. The Company reserves the right to charge interest in the event of payment being overdue at 5% over Barclays Bank plc base rate.

10. Risk

Risk in respect of goods shall pass upon delivery. When goods are by the Company’s own transport delivery shall be deemed to take place at the moment the goods are lifted from the delivery vehicle. When goods are delivered by other means of transport delivery shall be deemed to take place when the goods are handed or surrendered to the carriers.

11. Claims

No claim for material damaged in transit or suffering from any defect apparent from reasonable examination will be considered by the Company unless:-

(a) An appropriately qualified signature e.g. Material received damaged (signed), is clearly made by the customer on the proof of delivery note. AND

(b) The Company is advised in writing, in addition to (a) above, within 3 days of receipt of material. No claim or loss in transit can be considered unless advised by the customer in writing within 10 days of invoice or in case of shortage within 4 days from receipt of goods and the Customer has signed the proof of delivery note indicating the amount of shortages. In no circumstances shall the Company be responsible for loss, damage or delay due to shortage of materials arising from circumstances beyond the control of the Company or from industrial disputes, transport delays, accident, plant failure or any other contingency (whether or not of the same nature as the foregoing), arising from circumstances beyond the reasonable control of the Company. The Customer is to indemnify the Company against any claims whatsoever for damages and costs and against all liability in respect of any infringement of patent rights or registered design resulting from compliance with the Customers instructions expressed or implied.

12. Defective Products

The Company in no circumstances, will be liable to the Customer or user for any loss, damage or remedial expenses, whether direct or consequential, arising from the goods supplied by the Company for any purpose.

13. Return of Goods

The return of any goods properly supplied will not be accepted unless the Company’s authority has been previously agreed and a returns number given. Notice of such return must be in writing within 7 days of receipt of the goods. Returns must be delivered carriage paid accompanied by a separate advice note detailing the consignment. Conditional upon goods being received in perfect condition, suitable for immediate resale, goods will be credited at invoice or current value, less a handling charge of 25%. If any reconditioning is found necessary this will be charged.

14. Specials

Goods made to the Customer’s orders and/or specifications cannot under any circumstances be accepted for return or cancellation.

15. Specifications & Drawings

Unless otherwise agreed in writing all descriptive specifications, drawings and particulars of weights and dimensions, furnished by the Company are to be deemed approximate only and the description and illustrations contained in such documents are intended to represent a general idea of the product and not to form part of the contract.

16. Copyright

All drawings, descriptions and other information submitted by the Company shall remain the property of the Company together with the copyright therein and must not be disclosed or reproduced without the Company’s written authority.

17. Limits of Contract

Any quotation includes only such goods, accessories and work as are specified therein.

18. Limitations of Liability

The Company shall have no liability for any loss, delay, damage or claim arising out of the following:

(a) the Company’s inability to obtain adequate labour or materials due to any cause outside the Company’s control;

(b) prevention or delay in carrying out the works by reason of any cause outside the control of the Company including but not limited to any Act of God or force majeure.

(c) any act, omission, default or negligence by the Customer, its servants or agents.

(d) the Customer’s failure to obtain all necessary permits approvals or licences required by law or otherwise with respect to the Work. Any costs incurred by the Company arising out of any of the matters described in sub clause (c) and (d) of this clause shall be invoiced to the Customer and shall, fourteen days after the date of such invoice, be a debt due from the Customer to the Company. Any claims arising from the negligence of the Company its servants or agents shall be limited to the Company’s statutory liability.

(e) any infringement of patent rights or registered design resulting from compliance with the customer’s instructions express or implied. Provided always that the Company shall not be held liable for any damage caused by negligence of its servants or agents when engaged upon the Customer’s premises or otherwise, other than damage arising out of breach of contract.

19. Warranties

The Company warrants that it has exercised and will exercise all reasonable skill and care in:

(a) the design of the Work insofar as the Company has designed or will design the Work.

(b) the selection of goods and materials insofar as the Company has selected or will select the said goods and materials.

(c) the satisfaction of any performance specification or requirement provided always that such specification or requirement is included or referred to in the description of the Work or is agreed to in writing by the Company. Insofar as the Company has designed the Work such design shall at all times remain property of the Company and shall be used for no other purpose than the Work unless specifically agreed to in writing by the Company. No liability shall rest with the Company arising out of the unauthorised use of the design.

20. Insolvency

Should the customer commit any act of bankruptcy or make any composition or arrangement with its creditors or being a company has a winding up order made or (except for the purposes of reconstruction) a resolution for voluntary winding up passed or a receiver or manager or the business or undertaking is duly appointed or possession is taken by or on behalf of the holders of any debentures secured by a floating charge of any property comprised in or subject to the floating charge therein and in such case the Company, without prejudice to its accrued rights or remedies may by written notice determine its employment.

21. Retention of Title

All goods supplied by the Company to the Customer under the terms of any agreement shall remain the sole property of the Company both in law and in equity and the Customer acknowledges that it is in possession of all such goods solely as bailee for the Company until such time as the Customer shall have paid the Company the agreed price together with the full price of any other goods supplied by the Company pursuant to any other agreement between the Company and the Customer. Until such time as the Customer becomes the owner of the goods in accordance with the provisions of this clause, the Customer shall store such goods separately from its own goods or those of any other person or persons in such a manner as makes them readily identifiable as the Company’s goods. The Customer’s right to possession of the goods shall cease upon the occurrence of any of the events referred to in clause 20 hereof and the Company may thereupon enter upon any premises where the goods are stored or where they are reasonably thought to be stored for the purpose of repossessing the goods.

22. Legal Construction

Unless otherwise agreed by the Company in writing, these conditions shall in all respects be construed and operate as an English Contract, in conformity with the English Law.



Dalebrook[®]

Trusted Since 1945

EDITION 1

CONTACT US

LONDON SHOWROOM
28 Mortimer Street
W1W 7RD London. UK

+44 (0) 1376 510 101
sales@dalebrook.com
www.dalebrook.com



Search: Dalebrook Supplies

Images are to be used as a visual representation of final products only. Final products may vary in appearance.

